

# Technical Data

## Inductive Proximity Switch

### Series M12

Description **KIB-M12PS/002-KL6V**

Article number **6502903017**

#### Wiring Diagram

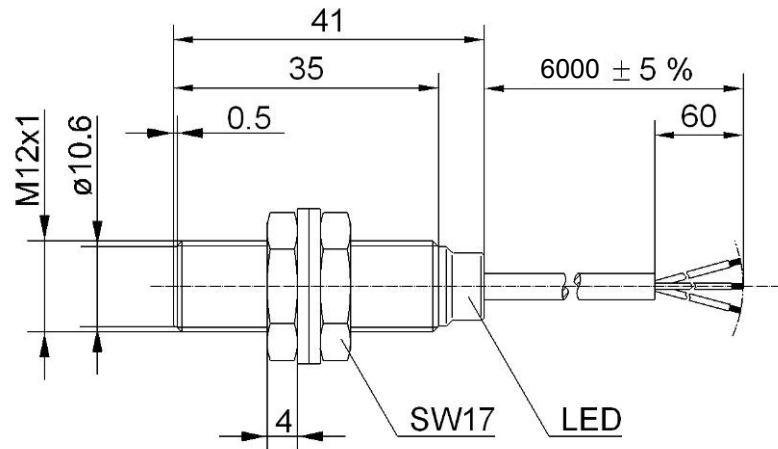
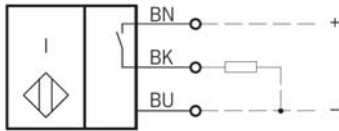

#### Identifying characteristics in accordance with EN 60947-5-2

Electrical data		
Rated operating distance	$S_n$	2 mm
Standard target		12 mm x 12 mm, t = 1 mm, Material: FE360
Effective operating distance	$S_r$	1,8 ... 2,2 mm
Assured operating distance	$S_a$	0 ... 1,6 mm
Switching element function		DC, N.O.
Repeat accuracy	R	≤ 5 %
Differential travel (hysteresis)	H	≈ 10 %
Rated operational voltage	$U_e$	12 – 24 V DC
Operational voltage range	$U_B$	10 – 36 V DC
Rated insulation voltage	$U_i$	75 V DC
Rated impulse withstand voltage	$U_{imp}$	500 V
Voltage drop	$U_d$	≤ 1,5 V
Utilization category		DC 13
Rated operational current	$I_e$	≤ 200 mA
Minimum operational current	$I_m$	≤ 1 mA
Off-state current	$I_r$	< 0,1 mA
No-load supply current	$I_o$	≤ 11 mA
Switching element		Permanent overload and s.c.p.
Short-circuit protection		pulsed
Frequency of operating cycles	f	800 Hz
Rated supply frequency		DC
Mounting		flush
False polarity protection		yes
Time delay before availability	$t_v$	≤ 50 ms

#### Electromagnetic compatibility (EMC)

Electromagnetic field test	IEC 61000-4-3
Electrostatic discharge test	IEC 61000-4-2
Electrical fast transient immunity test (Burst)	IEC 61000-4-4
Radiated disturbance field strength	EN 55011

This document will not become the contractual basis; the details included herein do not constitute any descriptions of expected conditions, so that warranties/claims for defects on account of possible variations of the actual qualities from the qualities described herein are explicitly excluded. All rights reserved. Specifications subject to change without notice!

Date of issue: 19.06.2013 / Page 1 of 2  
Document : 6502903017\_en / Last update: 2 / 0248-13

# Technical Data

## Inductive Proximity Switch



### Mechanical Data

Front cap	PA6.6, black
Enclosure	Brass, nickel plated
End cap	PA 12, transparent
Ambient air temperature	-25 °C ... +70 °C (cable fixed mounted)
Type of protection	IP67
Pollution degree	3 (Pollution of the active zone can cause impairments of the operating distances.)
Indication	LED, yellow
Termination type	Cable 3 x 0,14 mm <sup>2</sup> ; PVC – Outer jacket, black
For attachment	2 x hexagon nut and 2 x toothed washer

### Product reliability (in acc. with DIN EN 61709 (SN 29500))

MTTF (at nominal load, 40 °C)	> 900 years
-------------------------------	-------------

### EU Conformity

acc. to directive 2004 / 108 / EC

This document will not become the contractual basis; the details included herein do not constitute any descriptions of expected conditions, so that warranties/claims for defects on account of possible variations of the actual qualities from the qualities described herein are explicitly excluded. All rights reserved. Specifications subject to change without notice!

Date of issue: 19.06.2013 / Page 2 of 2  
Document : 6502903017\_en / Last update: 2 / 0248-13