

Anschlußbild

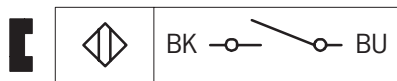

Schaltleistungsdiagramm

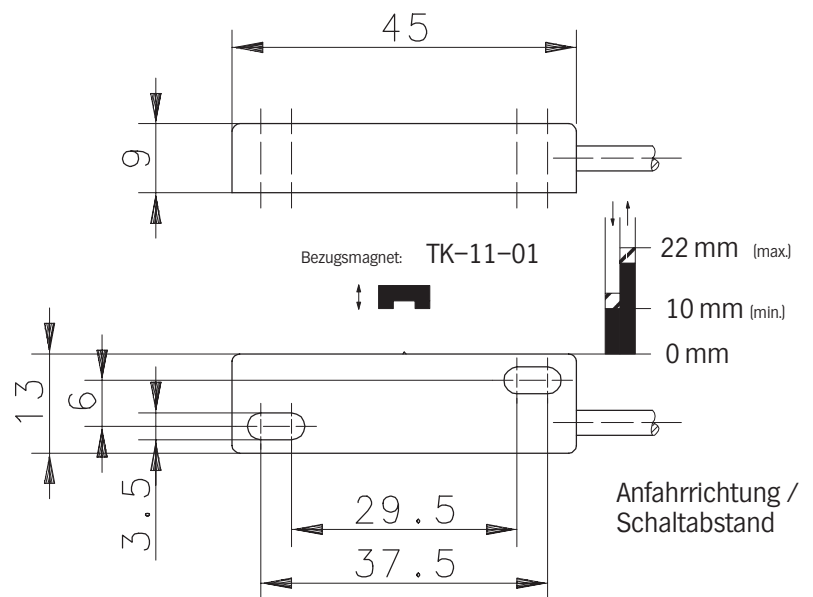
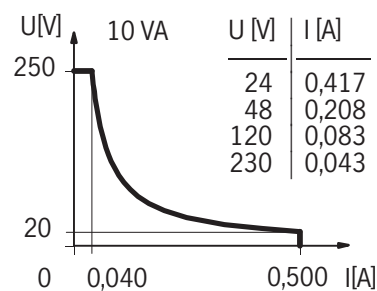

Technische Daten

Schaltspannung max.	:	230 V
Schaltstrom max.	:	0,5 A
Schaltleistung max.	:	10 VA
mech. Lebensdauer	:	3 x 10 ⁸ Schaltungen, je nach zu schaltender Last
Wiederholgenauigkeit	:	bei gleichen geometrischen Verhältnissen und gleicher Temperatur ± 0,1 mm
Temperaturbereich	:	-5 °C bis +70 °C
Schutzart	:	IP 67 nach IEC 529, EN 60529
Ausgangsfunktion	:	Schließer (andere Funktionen auf Anfrage)

Mechanische Eigenschaften

Gehäuse	:	PA 6.6, schwarz; Reedkontakt eingegossen
Anschlußart	:	Kabel 2 x 0,14 mm ² x 3 m; PVC-Mantel, schwarz (andere Längen auf Anfrage)
Einbaulage	:	beliebig (bei Montage auf ferromagnetischem Material reduziert sich der Schaltabstand)

Bei induktiven Lasten bitte Kontaktschutz beachten.

Wiring Diagram

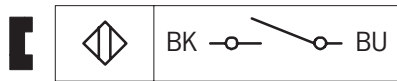

Switching diagram

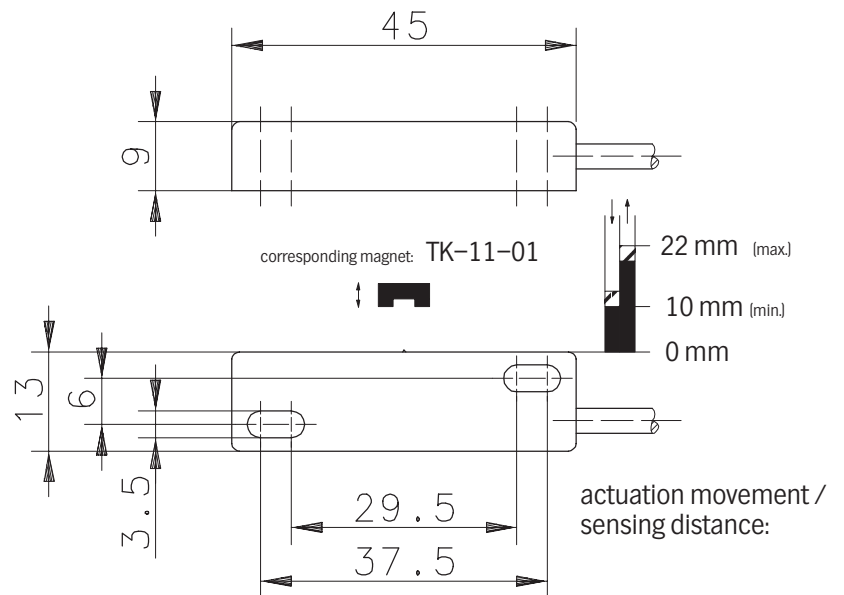
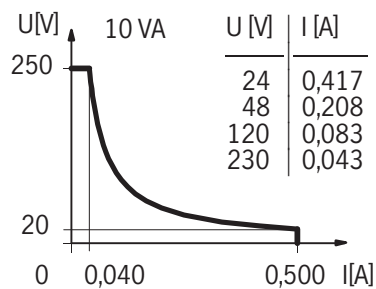

Technical Data

Max. Voltage	:	230 V
Max. Switch Current	:	0,5 A
Max. Switching	:	10 VA
Mech. Lifetime	:	3 x 10 ⁸ switchings, however, according to the load resetability
Repeat Accuracy	:	± 0,1 mm under same geometrical conditions at the same temperature
Temperature range	:	-5 °C ... +70 °C
Protection	:	IP 67 according to IEC 529, EN 60529 (Nema 4)
Output function	:	N.O. (other functions on request)

Mechanical Features

Housing	:	PA 6.6, black; encapsulated reed contact
Connection	:	Cable 2 x 0,14 mm ² x 3 m; PVC-Outer jacket, black (other lengths upon request)
Assembly position	:	optional (assembly on iron means reduction of switch distance)

Pay attention to the contact protection when switching inductive loads.