

# Safety switch

## Series SLK – with separate actuator

Description **SLK-F-UC-55-R1-A0-L0-21**

Article number **6118119154**

### Position monitoring of guard locking

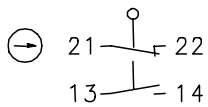

### Termination electromagnet with contact position E1, E2 without current

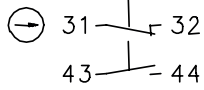
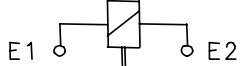

### E1, E2 with current

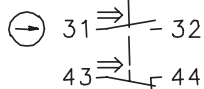
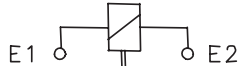

### Operating diagram

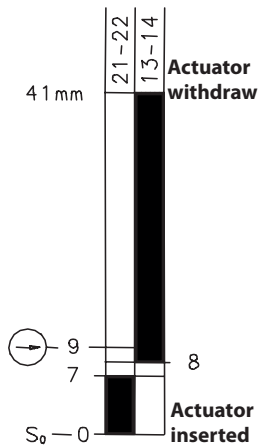

The actuator is not included in the scope of delivery. It can only be purchased in conjunction with the safety switch.

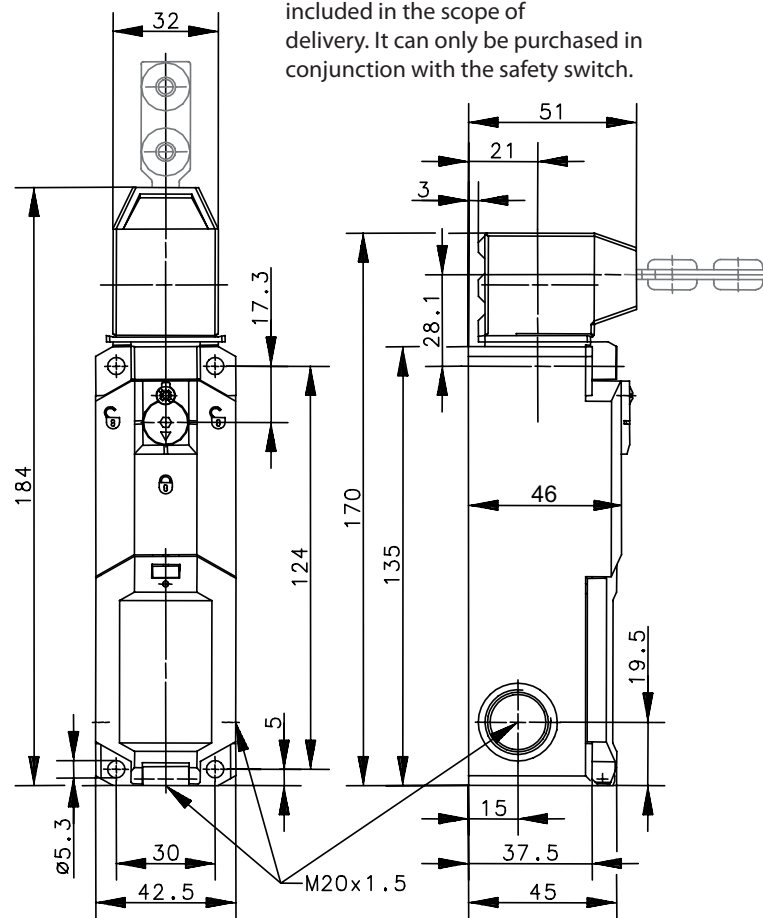

<b>Electrical data</b>	
Protection class	II, totally insulated
<b>Contact elements</b>	
Rated insulation voltage	$U_i$ 250 V
Rated impulse withstand voltage	$U_{imp}$ 2,5 kV
Conv. thermal current	$I_{the}$ 5 A
Utilization category	AC-15, $U_e / I_e$ 230 V / 2,5 A
Direct opening action	⊙ according to IEC/EN 60947-5-1, Annex K
Short-circuit protective device	4 A gG
<b>Electro magnets</b>	
Duty cycle	100 % ED (at E1; E2)
Temperature class	F (155 °C)
Inrush power consumption	12 VA (0,2 s)
Permanent power consumption	4,4 VA
Switch operations permanent	600 / h
Operating voltage	24 V AC / DC

<b>Mechanical data</b>	
Enclosure	Thermoplastic, glass fibre reinforced (UL 94-V0)
Cover	Thermoplastic, glass fibre reinforced (UL 94-V0)
Actuating head	Thermoplastic, glass fibre reinforced / Zn-GD
Actuator	Separate actuator (Steel / PA)
Minimum actuating radius	$R_{min}$ see separate actuators data sheet
Velocity for actuating	$V_{max}$ 0,5 m/s
Extraction force	≥ 27 N
Interlocking principle	Spring force
Unlocking	a) magnetic force b) auxiliary release from the front
Hold on force	$F_{Zh}$ ≤ 1500 N acc. to GS-ET-19
Ambient air temperature	-25 °C ... +70 °C
Contact type	2 NC, 2 NO
Switching principle	4 slow make and break contact elements
Contacts	fine gold-plated (Our guideline values are valid for the gold-plated switch contacts.)
Mechanical life	1 x 10 <sup>6</sup> switching cycles (at max. 600 switch operations / h)
Assembly	4 x M5
Connection	Spring-clamp connection
Conductor cross-sections	0,5 ... 1,5 mm <sup>2</sup> flexible
Cable entrance	3 x M20 x 1,5
Weight	≈ 0,34 kg
Installation position	operator definable
Protection type	IP67 acc. to IEC/EN 60529

<b>Actuation</b>
4 different actuating directions achievable by rotating the actuating head. Changing between horizontal and vertical actuating direction by setting the actuating head in the requested direction.

Standards	
	VDE 0660 T100, DIN EN 60947-1, IEC 60947-1
	VDE 0660 T200, DIN EN 60947-5-1, IEC 60947-5-1
	GS-ET-19

EU Conformity	
	acc. to directive 2014/35/EU (Low-Voltage-Directive)

Notes	
<p>The degree of protection (IP code) specified applies solely to a property closed cover and the use of an equivalent cable gland with adequate cable.</p> <p>The switch may not be used as a mechanical stop.</p> <p>When power is removed from the electromagnet (solenoid) the safety guard will be in locked position.</p> <p>To operate the manual release loosen the screw and turn the hexagonal nut 90°.</p>	