

Plastic bodied limit switch
Series IN65-modular system

Description **IN65-M16**

Article number **6083000247**

Enclosure without built-in switches without actuating device

Fixed positioning with
e.g. fixing screw M5
according to the standard
DIN EN ISO 4762.

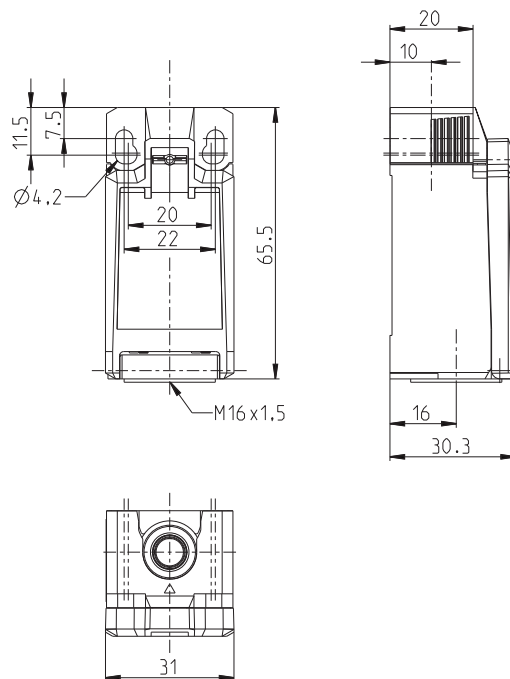
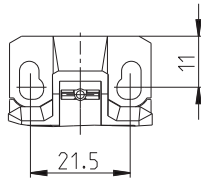

Mechanical data

Enclosure	Thermoplastic, glass fibre reinforced (UL 94-V0)
Cover	Thermoplastic, glass fibre reinforced (UL 94-V0)
Operating temperature	-30 °C ... +75 °C
Storage temperature	-40 °C ... +80 °C
Protection type	IP66 / IP67 acc. EN 60529
Cable entrance	1 x M16 x1,5
Weight	≈ 0,05 kg
Installation position	operator definable

Standards

UL 508 / CSA C22.2 No.14

EU Conformity

acc. to directive 2014/35/EU (Low-Voltage-Directive)

Approvals

cCSA_{US} B300, 240Vac 1.5A G.P., 24Vdc 1.5A R. Enclosure Type 4X

Notes

The degree of protection (IP code) specified applies solely to a property closed cover, the use of an equivalent cable gland with adequate cable and mounted actuating device.

The information on the switching travel can be found in the data sheets of the actuator, as these depend on the actuator used.

Approvals / properties applies only to the fully assembled device.