

Series F2 UN

Description

F2-ZSP1D/ZSP1D UN

Article number

6062000565

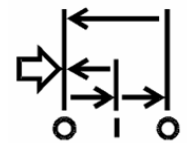
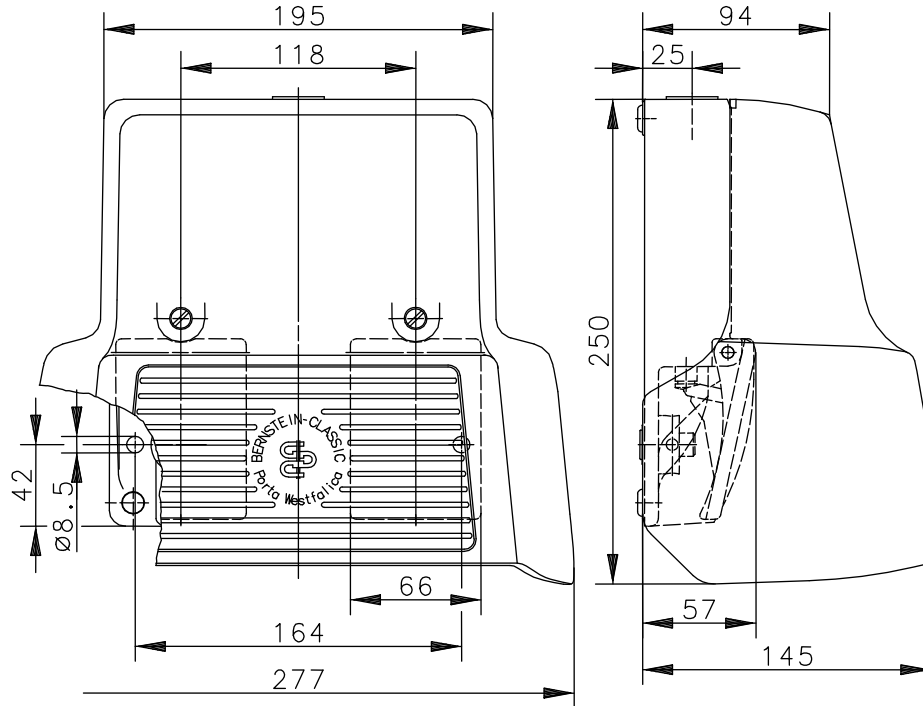

Switching symbol (applies to both pedals)
(Three-Step-Safety Switch)

1. position
Off-position

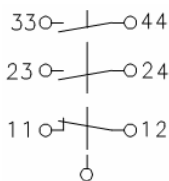

2. position
On-position

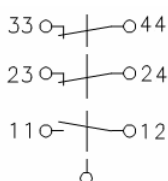

3. position
Off-position
with positive opening

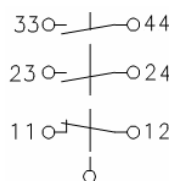

To reach the 3rd position,
the tactile touch has to be
surmounted.

Wiring diagram PNP additional board
(applies to both pedals)

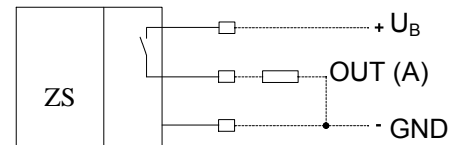

Operating diagramme

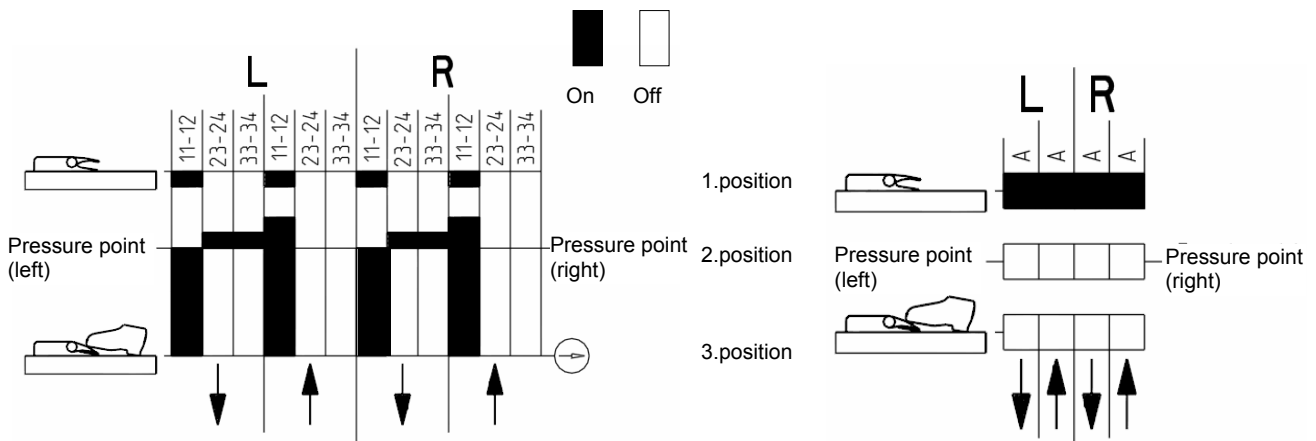

This document will not become the contractual basis; the details included herein do not constitute any descriptions of expected conditions, so that warranties/claims for defects on account of possible variations of the actual qualities from the qualities described herein are explicitly excluded. All rights reserved. Specifications subject to change without notice!

Electrical data PNP additional board

Switching element function		PNP, N.O.
Operational voltage range	U_B	10 - 39 V DC
Switching current		400 mA
Operational current		< 20 mA
Voltage drop	U_d	$\leq 1,5$ V
Short-circuit protection		pulsed
False polarity protection		yes

Electromagnetic compatibility (EMC) PNP additional board

Electromagnetic field test		IEC 61000-4-3
Electrostatic discharge test		IEC 61000-4-2
Electrical fast transient immunity test		IEC 61000-4-4
Radiated disturbance field strength		EN 55011

Electrical data safety switch

Rated insulation voltage	U_i	250 V
Conv. thermal current	I_{the}	5 A
Rated impulse withstand voltage	U_{imp}	2,5 KV
Rated operational voltage	U_e	240 V AC and 24 V DC
Utilization category		AC-15, U_e/I_e 240 V AC / 1,5 A 50-60 Hz DC-13, U_e/I_e 24 V DC/ 1,0 A
Direct opening action	\ominus	acc. to IEC/EN 60947-5-1, Annex K
Short-circuit protective device		D-Fuse 4 A gG
Protection class		I

Mechanical data

Enclosure		AL, die-cast
Protective guard (Accident protection cover UN)		AL, die-cast
Actuator		Foot lever (PA)
Ambient air temperature		Operating temperature range: -10 °C to +50 °C Storage temperature range: -25 °C to +70 °C
Contact type (each pedal)		1 NC, 2 NO. (Zb)
Operating force (pedal centre) (each pedal)	1. position	10 N
	2. position	25 N
Pressure point (each pedal)		≈ 200 N
Mechanical life (each pedal)		
Sequence of the switching position:	1 – 2 – 1	10×10^6 operating cycles
or:	1 – 2 – 3 – 1	1×10^6 operating cycles
Switching frequency		max. 30/min
Assembly		2 x M8
Connection		screw connections (M3,5)
Protection ground		2 x M4
Conductor cross-sections		Solid: 0.5 ... 1.5 mm ² Litz wire with ferrules: 0.5 ... 1.5 mm ²
Cable entrance		1 x M20 x 1,5
Weight		Approx. 2,3 kg
Protection type		IP66 / IP67 in accordance with IEC/EN 60529

ID for safety engineering

B10d - value	1×10^5
--------------	-----------------

This document will not become the contractual basis; the details included herein do not constitute any descriptions of expected conditions, so that warranties/claims for defects on account of possible variations of the actual qualities from the qualities described herein are explicitly excluded. All rights reserved. Specifications subject to change without notice!

Regulations	VDE 0660 T100, DIN EN 60947-1, IEC 60947-1 VDE 0660 T200, DIN EN 60947-5-1, IEC 60947-5-1 DIN EN 61326-3-1 EN 13849
EU Conformity	acc. to directive 2006/95/EG
Approvals	cUL _{us}

Function

Normally open contacts: 23 – 24, 33 – 44; Signalling contact: 11 – 12

- Position 1: OFF position of the operating contacts (the pedal is not actuated)
- Position 2: ON position of the operating contacts (the pedal is actuated to as far as the pressure point)
- Position 3: OFF position of the operating contacts (the pedal is fully actuated)

If the three-stage enable switch is actuated in position 2, it returns to position 1 when it is released. The three-stage enable switch changes from position 2 to position 3, if it gets further pressed under after the resistance of the pressure point.

The actuation of the operating contacts is made by a positive opening.

Once the pedal is not pressed, the three-stage enable switch returns to position 1.

The operating contacts are opened in the return stroke.

Notes

The specified protection classification (IP code) applies only when the cover is closed and the appropriate cable is used, in accordance with the clamping range of the above mentioned cable gland.