

Safety switch

Series Safety Hinge Switch SHS3

Description **SHS3-7-SA/7-SA**

Article number **6019390039**

Operating symbol

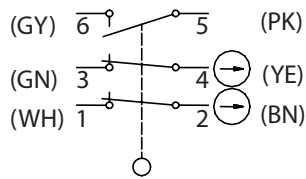

The colour allocation refers to the plug-in-cables which we have in our range.

Plug

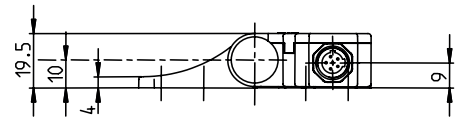
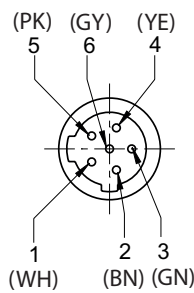

Operating diagram

(is valid for both switches)

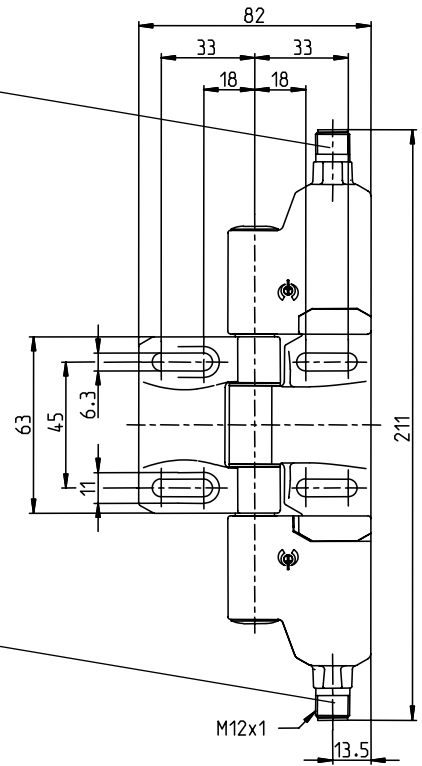
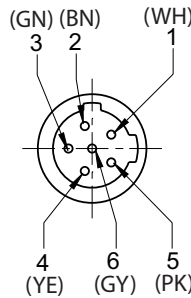
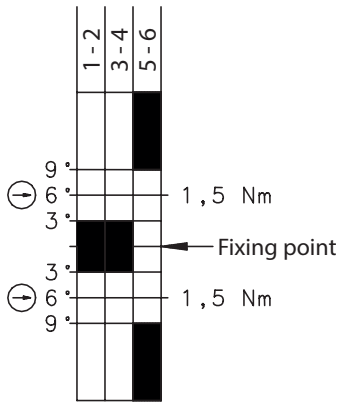

Point of fixation is in range of 0° ... 270° free selectable.



Tolerances:

- switching angle (opening) $\pm 1,5^\circ$,
- direct opening torque 10 %,
- direct opening angle $+ 2^\circ$

Swivel angle 0° to 270°

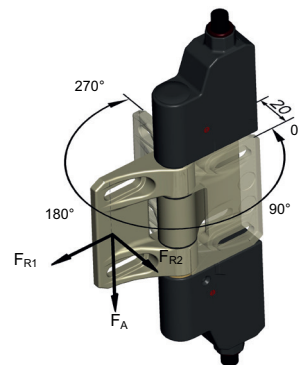

6-pole connector M12x1 with jiggle protection and molded cable					
Article number	Description	Cable length x	Article number	Description	Cable length x
325.1006.291	AN-KAB.SHS3	2 m straight	325.1006.294	AN-KAB.SHS3	2 m angled
325.1006.292	AN-KAB.SHS3	5 m straight	325.1006.295	AN-KAB.SHS3	5 m angled
325.1006.293	AN-KAB.SHS3	10 m straight	325.1006.296	AN-KAB.SHS3	10 m angled

Connector straight	Connector angled
--------------------	------------------

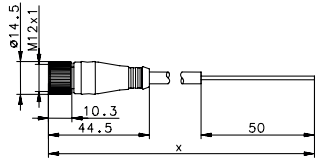
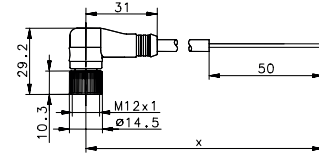
Electrical Data		
Rated insulation voltage	U_i	250 V
Conv. thermal current	I_{the}	4 A
Rated operational voltage	U_e	230 V AC; 24 V DC
Utilization category		AC-15, U_e / I_e 230 V / 3 A; DC-13, U_e / I_e 24 V / 1 A
Direct opening action	⊖	acc. to IEC/EN 60947-5-1, annex K
Short-circuit protective device		Fuse 4 A gG
Protection class		II (totally insulated)

Mechanical data	
Enclosure	PBT
Hinge	Cast stainless steel
Ambient air temperature	-25 °C to +70 °C (connecting cable permanently mounted; no freezing over / no condensation)
Contact type	Slow make and break contacts 2 N.C., 1 N.O.
Mechanical life	1 x 10 ⁶ operating cycles
Switching frequency	max. 300 switching operations / hour
Attachment	4 x M6 screws DIN EN ISO 7984 (on flat and stiff ground)
Wiring	6-pin connector M12x1 (Dual-Key-Way) Equivalent connecting cable available as accessory
Weight	≈ 0,45 kg
Installation position	operator definable
Protection type	IP 67 in acc. with IEC/EN 60529
Switching angle	+/- 3 ° from fixing point for the N.C. contacts and 9° for the N.O. contact
Forced disconnect angle	6°+2° from fixation point in both directions (for 0°-3° only in Plus-direction, for 267°-270° only in Minus-direction)
Forced disconnect torque	1,5 Nm
Mechanical load (see dimensioned drawing for the introduction direction of the forces)	F_{R1} = max. 1800 N F_{R2} = max. 750 N F_A = max. 1800 N

ID for safety engineering	
B10d	2 x 10 ⁶ cycles

Standards	
	DIN EN 60947-5-1
	DIN EN ISO 13849-1

EU Conformity	
	acc. to directive 2006/42/EC (Machinery Directive)

Approvals	
	DGUV
	CCC
	cCSA _{US} B300

Notes	
<p>The safety guard shall always be mounted using two SHS3 at least! See max. load. If the risk assessment of the machine permits a single-channel monitoring a blank hinge can be used as bearing element.</p> <p>High forces, unfavourable force application as well as dynamic loads can shorten the service life.</p> <p>In case that the SHS3 is used at an ambient temperature of 70° an accelerated ageing of the connecting cable can occur.</p> <p>The connecting cable shall be protected against mechanical damages.</p> <p>The installation of the connecting cable can be done via pipes or cable ducts.</p> <p>The manufacturer / supplier of the machine / equipment is obliged to take the applicable standards for the calculation of the safety distances of separating safety guards to hazardous areas into account.</p> <p>Especially these standards apply: DIN EN 349, DIN EN 953, DIN EN ISO 14119, DIN EN ISO 13857, ...</p> <p>The switch shall not be used as a mechanical stop.</p>	