

Safety switch

Series SLC

Description **SLC-F-024-20/11-R4**

Article number **601820009**

Position monitoring (Guard lock L)	
<p>Actuator inserted Guard closed and locked</p> <p>without current</p>	<p>Actuator inserted Guard closed and not locked</p> <p>with current</p>
<p>Actuator withdraw Guard not closed and not locked</p> <p>with or without current</p>	

The actuator is not included in the scope of delivery. It can only be purchased in conjunction with the safety switch.

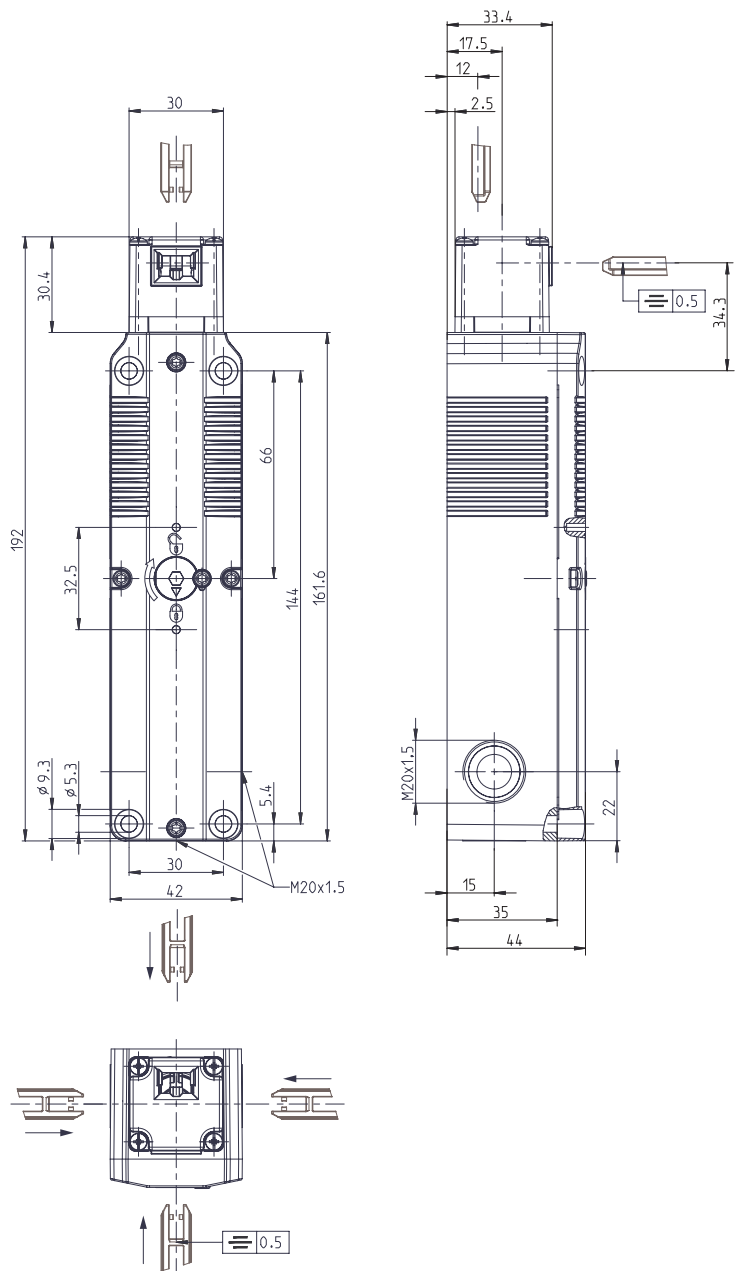

Electrical data	
Protection class	II, totally insulated
Contact elements	
Rated insulation voltage	U_i 250 V
Rated impulse withstand voltage	U_{imp} 2,5 kV
Rated operational voltage	U_e 240 V AC / 24 V AC/DC
Conv. thermal current	I_{the} 5 A
Utilization category acc. to IEC	AC-15, U_e / I_e 240 V / 1,5 A DC-13, U_e / I_e 24 V / 1,5 A; 250 V / 0,11 A
Utilization category acc. to UL / CSA	B300 R300 (same polarity)
Performance at min. current	1 mA, at 24V DC, U_{KD} 2,4V DC
Direct opening action	⊖ according to IEC/EN 60947-5-1, Annex K
Short-circuit protective device	4 A gG
Rated conditional short-circuit current	400 A
Electro magnet	
Duty cycle	100 % ED (at E1; E2)
Temperature class	F (155 °C)
Permanent power consumption	6,7 VA (W)
Switch operations permanent	10 / min
Operating voltage	24 V AC / DC (+10 % / -15 %)

Mechanical data	
Enclosure	Thermoplastic, glass fibre reinforced (UL 94-V0)
Cover	Thermoplastic, glass fibre reinforced (UL 94-V0)
Actuating head	Thermoplastic, glass fibre reinforced / Zn-GD
Actuator	Separate actuator
Minimum actuating radius	R_{min} see separate actuators data sheet
Velocity for actuating	V_{max} 0,5 m/s
Extraction force	≤ 10 N
Interlocking principle	Spring force
Unlocking	a) magnetic force b) auxiliary release from front and back side
Holding force	F_{Zh} 1500 N (EN ISO 14119)
Ambient air temperature	-25 °C to +55 °C
Contact type	Interlock: 2 NC Guard lock (L): 1 NC, 1 NO
Switching principle	4 slow make and break contact elements
Mechanical life	1 x 10 ⁶ switching cycles
Assembly	4 x M5
Connection	Screw connection
Conductor cross-sections	0,34 ... 1,5 mm ² flexible
Cable entrance	3 x M20x1,5
Weight	≈ 0,484 kg
Installation position	operator definable
Protection type	IP67 acc. to IEC/EN 60529 ; (UL 50 E / CSA C22.2) Type 6 indoor use only

ID for safety engineering	
B10d	2 x 10 ⁶ Cycles (at DC-13; 24 V; 0,1 A)

Standards	
	DIN EN 60947-5-1, DIN EN 60947-5-4
	UL 508 18th Edition, CSA-C22.2 No.14-18
	GS-ET-19 (DGUV)
	DIN EN ISO 14119
	DIN EN ISO 13849-1

EU Conformity	
	acc. to directive 2006/42/EC (Safety-of-Machinery-Directive)

Approvals	
	DGUV
	cCSA _{US}
	CCC

Notes	
<p>The degree of protection (IP code) specified applies solely to a property closed cover and the use of an equivalent cable gland with adequate cable.</p> <p>The switch may not be used as a mechanical stop.</p> <p>In the event of a power failure, the guard remains locked.</p>	