

Safety switch Series SLC

Description **SLC-F-230-11/11-R4**

Article number **601820005**

Position monitoring (Interlock D / Guard lock L)	
Actuator inserted Guard closed and locked	Actuator inserted Guard closed and not locked
 <p>without current</p>	 <p>with current</p>
 <p> E1 ◯ 13 ◯ E2 ◯ 14 D 21 ◯ 22 ◯ 31 ◯ 32 ◯ 43 ◯ 44 L </p>	 <p> E1 ◯ 13 ◯ E2 ◯ 14 D 21 ◯ 22 ◯ 31 ◯ 32 ◯ 43 ◯ 44 L </p>
Actuator withdraw Guard not closed and not locked	
 <p>with or without current</p>	
 <p> E1 ◯ 13 ◯ E2 ◯ 14 D 21 ◯ 22 ◯ 31 ◯ 32 ◯ 43 ◯ 44 L </p>	

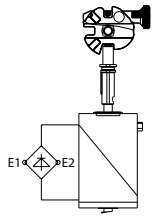
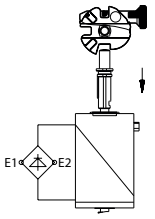
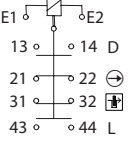
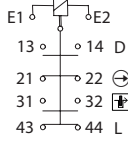
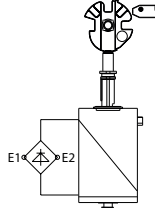
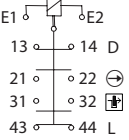
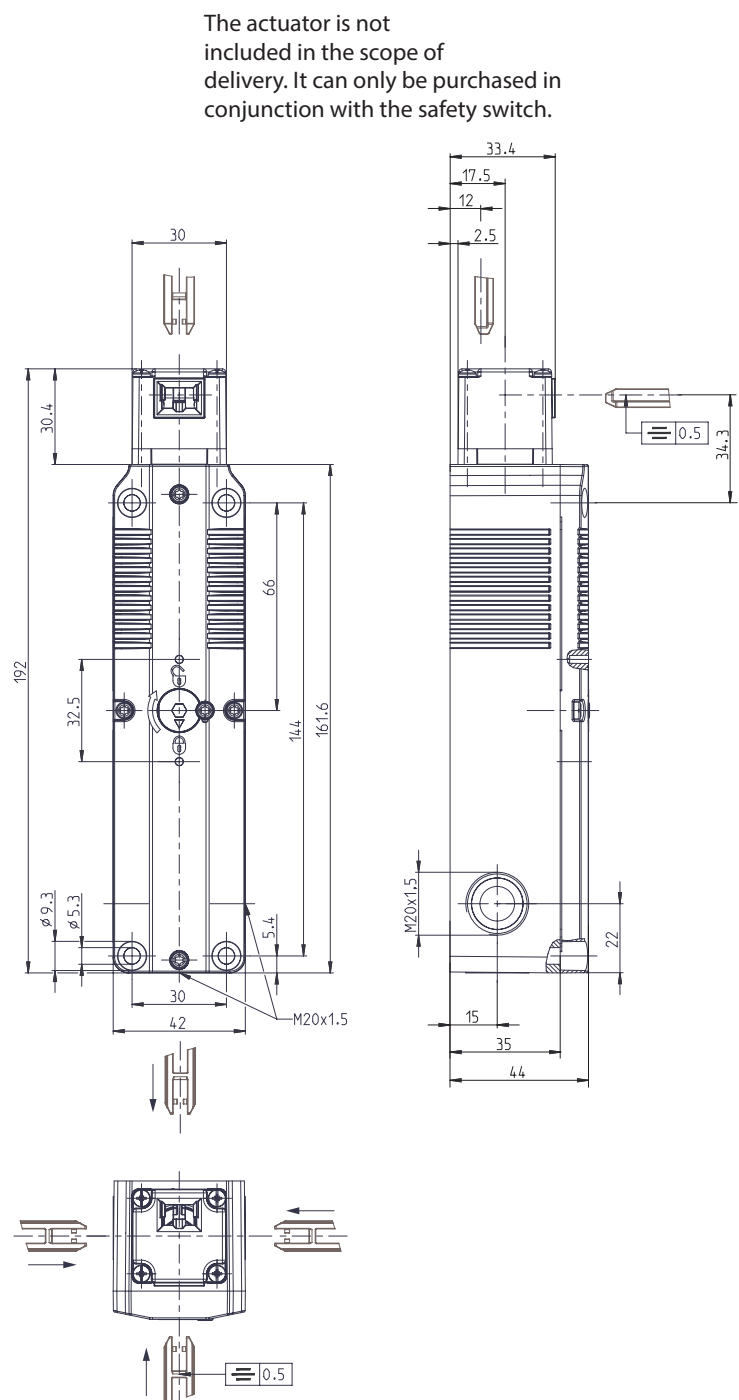

Electrical data	
Protection class	II, totally insulated
Contact elements	
Rated insulation voltage	U_i 250 V
Rated impulse withstand voltage	U_{imp} 2,5 kV
Rated operational voltage	U_e 240 V AC / 24 V AC/DC
Conv. thermal current	I_{the} 5 A
Utilization category acc. to IEC	AC-15, U_e / I_e 240 V / 1,5 A DC-13, U_e / I_e 24 V / 1,5 A; 250 V / 0,11 A
Utilization category acc. to UL / CSA	B300 R300 (same polarity)
Performance at min. current	1 mA, at 24V DC, U_{KD} 2,4V DC
Direct opening action	⊖ according to IEC/EN 60947-5-1, Annex K
Short-circuit protective device	4 A gG
Rated conditional short-circuit current	400 A
Electro magnet	
Duty cycle	100 % ED (at E1; E2)
Temperature class	F (155 °C)
Permanent power consumption	7,1 VA (W)
Switch operations permanent	10 / min
Operating voltage	230 V AC (+10 % / -15 %)

Mechanical data	
Enclosure	Thermoplastic, glass fibre reinforced (UL 94-V0)
Cover	Thermoplastic, glass fibre reinforced (UL 94-V0)
Actuating head	Thermoplastic, glass fibre reinforced / Zn-GD
Actuator	Separate actuator
Minimum actuating radius	R_{min} see separate actuators data sheet
Velocity for actuating	V_{max} 0,5 m/s
Extraction force	≤ 10 N
Interlocking principle	Spring force
Unlocking	a) magnetic force b) auxiliary release from front and back side
Holding force	F_{Zh} 1500 N (EN ISO 14119)
Ambient air temperature	-25 °C to +55 °C
Contact type	Interlock (D): 1 NC, 1 NO Guard lock (L): 1 NC, 1 NO
Switching principle	4 slow make and break contact elements
Mechanical life	1 x 10 ⁶ switching cycles
Assembly	4 x M5
Connection	Screw connection
Conductor cross-sections	0,34 ... 1,5 mm ² flexible
Cable entrance	3 x M20x1,5
Weight	≈ 0,484 kg
Installation position	operator definable
Protection type	IP67 acc. to IEC/EN 60529 ; (UL 50 E / CSA C22.2) Type 6 indoor use only

ID for safety engineering	
B10d	2 x 10 ⁶ Cycles (at DC-13; 24 V; 0,1 A)

Standards	
	DIN EN 60947-5-1, DIN EN 60947-5-4
	UL 508 18th Edition, CSA-C22.2 No.14-18
	GS-ET-19 (DGUV)
	DIN EN ISO 14119
	DIN EN ISO 13849-1

EU Conformity	
	acc. to directive 2006/42/EC (Safety-of-Machinery-Directive)

Approvals	
	DGUV
	cCSA _{US}
	CCC

Notes	
<p>The degree of protection (IP code) specified applies solely to a property closed cover and the use of an equivalent cable gland with adequate cable.</p> <p>The switch may not be used as a mechanical stop.</p> <p>In the event of a power failure, the guard remains locked.</p>	