

Safety rope pull switch

Series SRO

Description **SRO-M78-31-VT30-1**

Article number **6012891139**

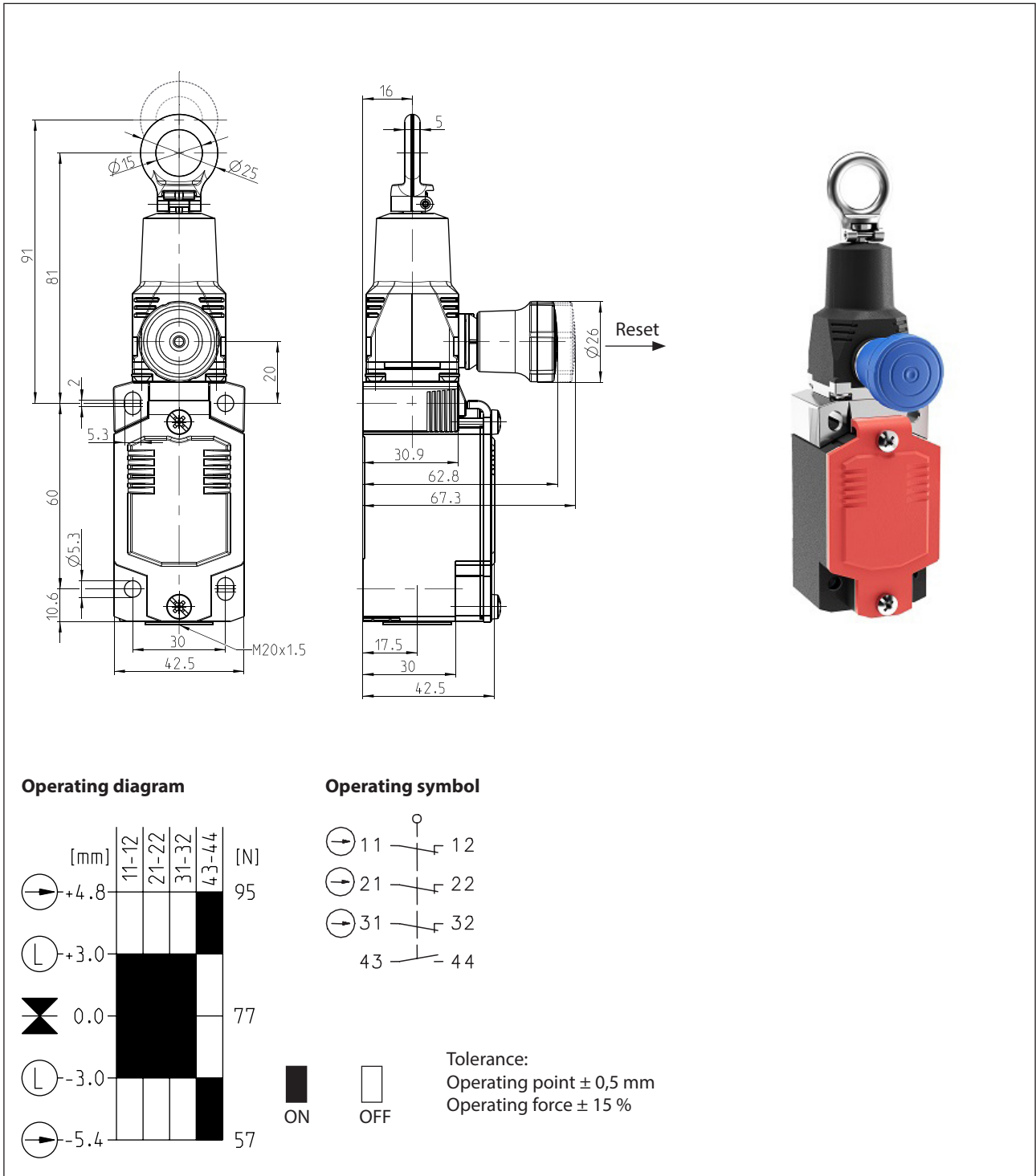

Electrical Data		
Rated insulation voltage	U_i	250 V
Rated impulse withstand voltage	U_{imp}	2,5 kV
Rated operational voltage	U_e	240 V AC / 24 V DC
Rated supply frequency AC		50 / 60 Hz
Conv. thermal current	I_{the}	5 A
Minimum current		1 mA
Utilization category		AC 15, U_e/I_e 240 V / 1,5 A; DC 13, U_e/I_e 24 V / 1,5 A
Direct opening action	⊖	acc. IEC/EN 60947-5-1, annex K; direct opening force: 125 N
Short-circuit protective device		Fuse 4 A gG
Rated conditional short-circuit current		400 A
Protection class		I

Mechanical data	
Enclosure	Die-cast aluminium
Cover	Sheet aluminium
Actuator	Pull ring (Zn-die cast)
Reset button	Thermoplastic, glass fibre reinforced (UL 94-V0)
Operating temperature	-30 °C ... +75 °C
Storage temperature	-40 °C ... +80 °C
Protection type	IP66 / IP67 acc. EN 60529; Type 4X
Pollution degree (built-in switch)	3
Contact material	silver
Contact type	3 N.C. (Form Zb), 1 N.O.
Latching device	acc. to IEC 60947-5-5, DIN EN 60947-5-5, ISO 13850 (DIN EN 418)
Reset facility	pull of the reset button acc. to IEC/EN 60947-5-5
Switching frequency	≤ 20 / min.
Mechanical life	1 x 10 ⁵ operating cycles
Mission time	≤ 20 years
Rope length	≤ 30 m (depends on the max. temperature variation)
Rope Ø	D = Ø 2 - 5 mm
Connection	8 screw connections (M3)
Earth bolt	1 x M3,5
Conductor cross-sections	Solid or Litz wire with ferrules 0,34 mm ² - 1,5 mm ² ; AWG 22-16
Cable entrance	1 x M20 x1,5
Weight	≈ 0,310 kg
Installation position	operator definable

Actuation
By lifting the clamp the actuation assembly can be rotated in 90° increments. The actuation assembly is to be again fastened to the housing by lowering the clamp.

ID for safety engineering	
B10d N.C.	2 x 10 ⁵ cycles
B10d N.O.	2 x 10 ⁵ cycles

Standards	
	DIN EN 60947-5-1
	DIN EN 60947-5-5,
	UL 508 / CSA C22.2 No.14
	ISO 13850
	DIN EN ISO 13849-1

EU Conformity	
	acc. to directive 2006/42/EC (Safety-of-Machinery-Directive)

Approvals	
	CCC
	cUL _{us}
	DGUV

Notes	
The degree of protection (IP code) specified applies solely to a properly closed cover and the use of an equivalent cable gland with adequate cable.	