

Coupling

Series M12x1 with vibration lock

Description **AN-KAB.SH53 2M WINKEL**

Article number **3251006294**

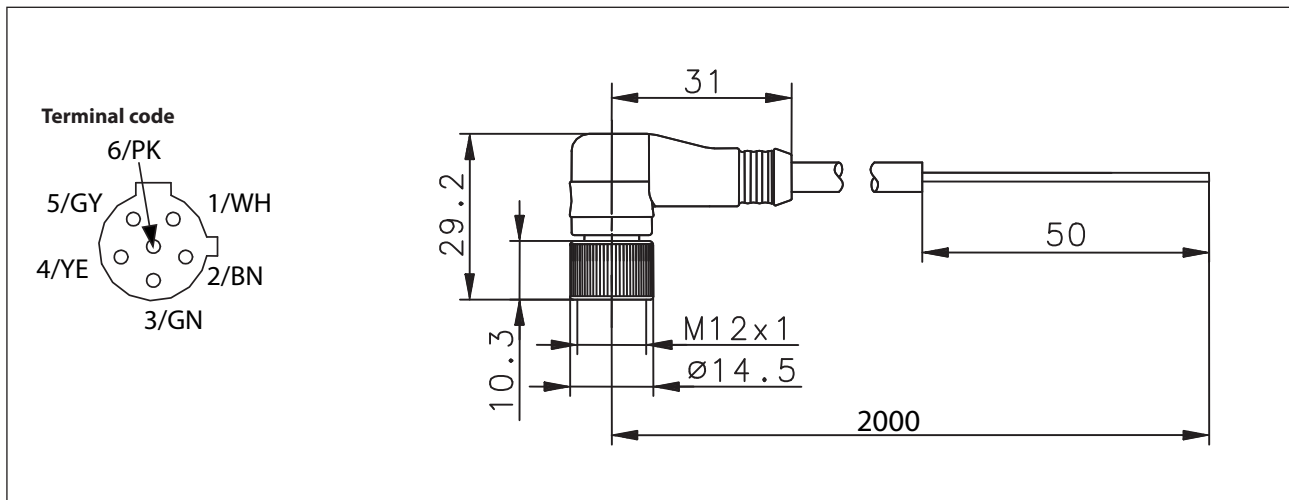

Electrical Data

Nominal voltage	250 V AC
Rated current	2,5 A (at 70 °C)
Insulation resistance	$\geq 10^9 \Omega$

Mechanical Data

Number of contacts	6
Degree of protection	IP68
Temperature range	-5 °C ... +105 °C (for flexing applications) -40 °C ... +105 °C (for fixed installation)
Material	Internal pin body: Elastollan R3000 Coupling nut: E-Coated Zinc Moulded cable: PUR Cable: LiYwUL2517 6 x 0,34 mm ² Cable – outer jacket: PVC (Ø5,6 mm)