

Technical data



Standard enclosure

Series CA

Type description CA-290 Bahn

Article number 1290950000

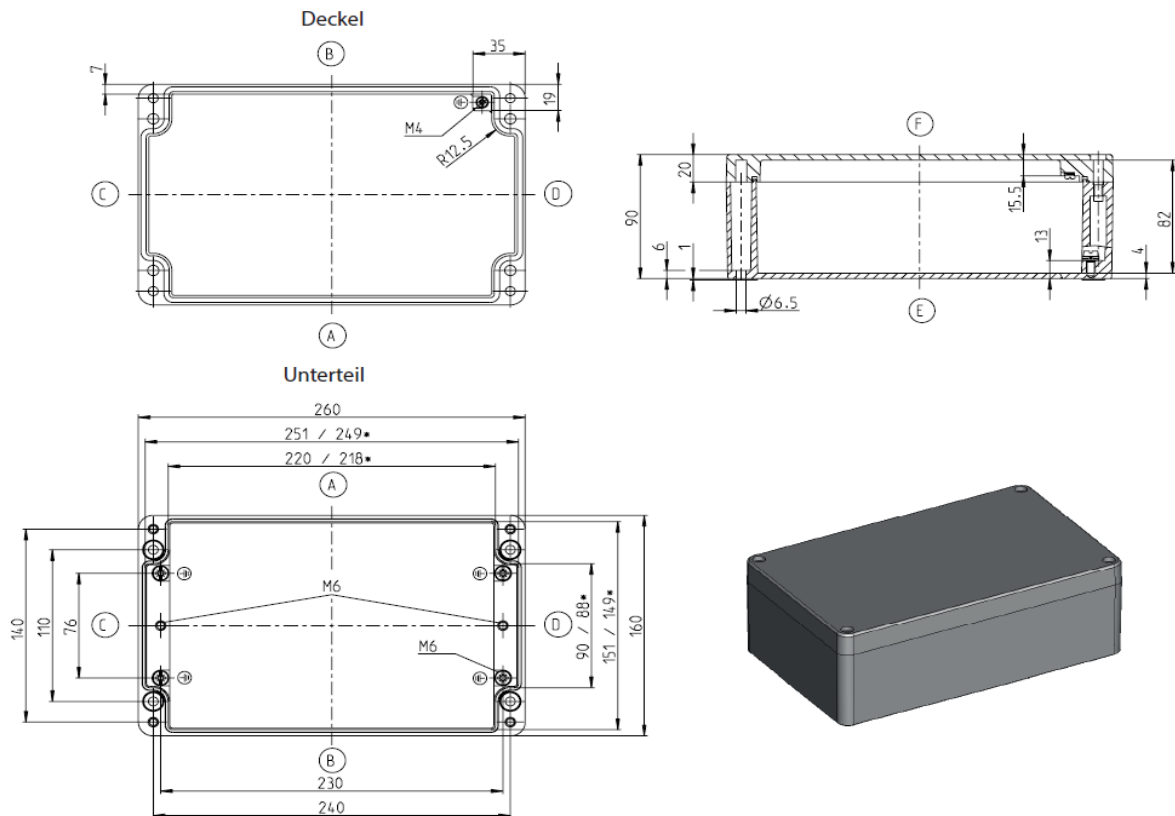

* smaller dimension in the height of the support surface of the mounting plate

CA-290

Standard version

Scope of delivery:

- Gehäuseunterteil / Lower part of enclosure / Partie inférieure du boîtier
- Gehäusedeckel / Enclosure lid / Couvercle du boîtier
- Deckelschrauben (Kombi-Kreuzschlitz) lose beigelegt / Cover screws (combination slotted head) enclosed loose / Vis de couvercle (à fente cruciforme combinée) fournies en vrac
- Erdungsschraube im Unterteil und Deckel / Grounding screw in the base and lid / Vis de mise à la terre dans la partie inférieure et le couvercle
- RAL9005 (tiefschwarz) / RAL9005 (deep black) / RAL9005 (noir intense)
- Deckeldichtung PUR / lid gasket PUR / Joint de couvercle PUR
- Einzelverpackung in Folie / Single packaging in foil / Emballage individuel sous film

Maximum possible number of threads (data for same diameter, not mixed!)

ISO M	M12	M16	M20	M25	M32	M40	M50	M63
Side A/B	36	17	12	7	4	3	3	0
Side C/D	8	4	3	2	2	0	0	0

BERNSTEIN AG . Hans-Bernstein-Straße 1 . 32457 Porta Westfalica . www.bernstein.eu

Technical changes and errors excepted.

This data sheet corresponds to the technical status as of 07.12.2023 [TT.MM.JJJJ] and will not be withdrawn in the event of changes.

Technical data



Standard enclosure
Series CA

Properties table CA-290 Bahn Article number 1290950000

Specification	Value	according to standard	Comment
General data			
Weight	1960g		
External dimensions	260x160x90		
Degree of protection			
<i>IP code</i>	IP66	DIN EN 60529	
<i>IP code</i>	IP67	DIN EN 60529	
<i>IK code</i>	IK09	DIN EN 62262	
Materials			
<i>Enclosure</i>	EN AC-ALSi12Cu1 (Fe) EN AC-47100	DIN EN 1706:05/98	Aluminium die casting Alloy 231
<i>Lid fastener</i>	A2-70	DIN EN ISO 3506-1	Lid screws
<i>Additional screws</i>	—	—	—
<i>Spring washer</i>	—	—	—
<i>Press-in nut</i>	—	—	—
<i>Seal</i>	PUR	—	Colour: black-grey 2K-polyurethane foam gasket
Toxic behaviour	Halogenfrei / Halogen-free / Sans halogène		—
Mechanical properties			
Torques			
<i>Cover fastener</i>	2,5 Nm		—
<i>Ground screw</i>	2,5 Nm 2,0 Nm		Base Lid
<i>Fastening accessories</i>	2,5 Nm		e.g. support rail, mounting plate
<i>Other fastening</i>	2,5 Nm		Screw channel
Maximum installation weight	2,6 Kg		—
Thermal properties			
Temperature range			
<i>Enclosure complete</i>	-40°C bis +90°C	—	Housing standard powder coated
<i>Enclosure material</i>	—	—	—
<i>Seal</i>	-40°C bis +100°C	—	PUR
Fire behaviour			
<i>Flammability</i>	—	—	—
<i>Glow wire test</i>	—	—	—
Temperature index Enclosure material			
<i>RTI (tensile strength)</i>	—	—	—
<i>RTI (impact strength)</i>	—	—	—
<i>RTI (dielectric strength)</i>	—	—	—
Heat resistance			
<i>Insulation class</i>	—	—	—
Fire behaviour - Fire protection in railway vehicles according to EN 45545-2:2020-10			
<i>Requirement set R1</i>	HL1 / HL2H / HL3	EN 45545-2:2020-10	—
<i>Requirement set R6</i>	HL1 / HL2H / HL3	EN 45545-2:2020-10	—
<i>Requirement set R7</i>	HL1 / HL2H / HL3	EN 45545-2:2020-10	—
Oxygen index	—	—	—
Storage temperature	-20°C bis +60°C	—	—
Thermal resistance	1,93 K/W	—	taking into account the effective power loss

BERNSTEIN AG . Hans-Bernstein-Straße 1 . 32457 Porta Westfalica . www.bernstein.eu

Technical changes and errors excepted.

This data sheet corresponds to the technical status as of 07.12.2023 [TT.MM.JJJJ] and will not be withdrawn in the event of changes.

Technical data



Standard enclosure
Series CA

Properties table CA-290 Bahn

Article number 1290950000

Specification	Value	according to standard	Comment
Usual operating conditions according to DIN EN 62208			
Ambient temperature			
<i>Indoor installation</i>	-5°C bis +40°C	—	on average over 24h +35°C
<i>Outdoor installation</i>	-25°C bis +40°C	—	on average over 24h +35°C
Relative humidity			
<i>Indoor installation</i>	max. 50% bei +40°C	—	at low temperatures also higher (e.g. 90% at 20°C); occasionally condensation permissible
<i>Outdoor installation</i>	zeitweise / temporary / temporairement 100 % bei +25°C	—	at low temperatures also higher (e.g. 90% at 20°C); occasionally condensation permissible
Chemical properties			
Corrosion resistance	Schärfe A	DIN EN 62208/9.13.2.1	IEC 60068-2-30 and IEC 60068-2-11
Corrosion resistance	Schärfe B	DIN EN 62208/9.13.2.2	IEC 60068-2-30 and IEC 60068-2-11
Salt spray test	—	—	—
Resistance list for enclosure materials and seals			see catalogue details
Electrical properties			
Protection class	I	EN 61140 / VDE 0140-1	 Protection by protective conductor
Rated voltage	max. 1000V (AC) max. 1500V (DC)	—	—
Surface resistance	—	IEC 60093	—
Dielectric strength	—	IEC 60243-1	—
Further specifications			
General tolerances			
<i>Casting tolerance</i>	DCTG 7 - GCTG 3	DIN EN ISO 8062-3	Casting tolerance
<i>Machining tolerance</i>	mH	DIN ISO 2768	Machining tolerance
Product standard	konform/compliant/conforme	DIN EN 62208	Empty enclosures for low-voltage switchgear and controlgear assemblies
Approval			
<i>c UL us</i>	—	UL 508A / C22.2	Typ 1, 4, 4x, 12, 13 with label on request
<i>ATEX / IECeX</i>	 —  —	—	on request
<i>DNV</i>	—	—	—
Conformities / Directives			
<i>Directive 2011/65/EU (RoHs)</i>	konform/compliant/conforme	2011/65/EU (RoHs)	RoHs
<i>Low Voltage Directive</i>	konform/compliant/conforme	2014/35/EU	—
<i>Electrical Equipment (safety) Regulations 2016 (CA UK)</i>	konform/compliant/conforme	2016 NO.1101	—

BERNSTEIN AG . Hans-Bernstein-Straße 1 . 32457 Porta Westfalica . www.bernstein.eu

Technical changes and errors excepted.

This data sheet corresponds to the technical status as of 07.12.2023 [TT.MM.JJJJ] and will not be withdrawn in the event of changes.