

Type FLEX.BASE

Article number 1016552200

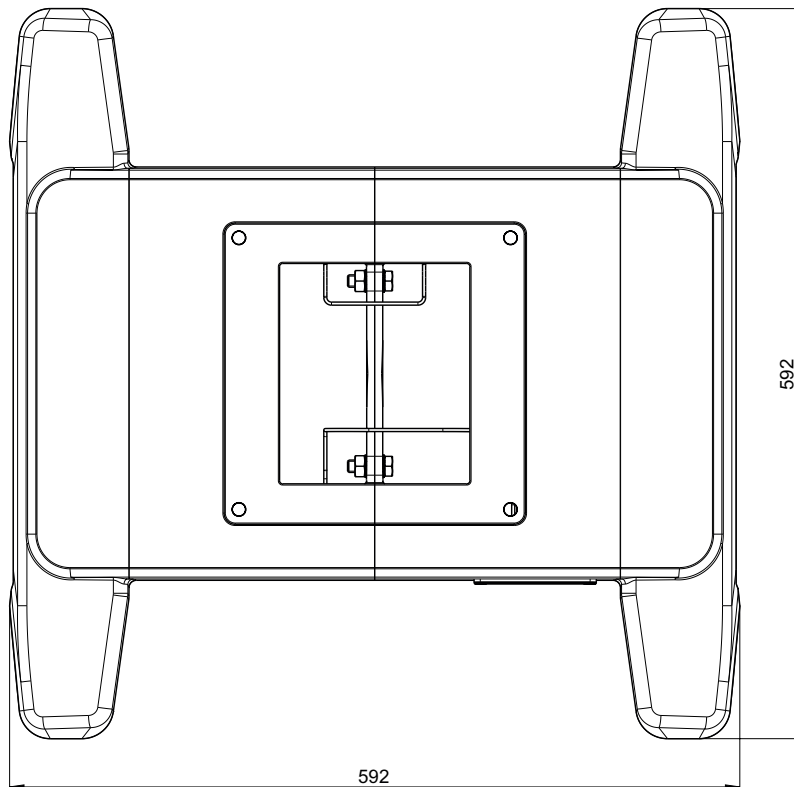

Component pictograms

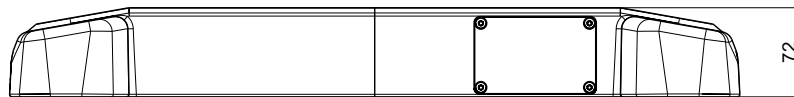
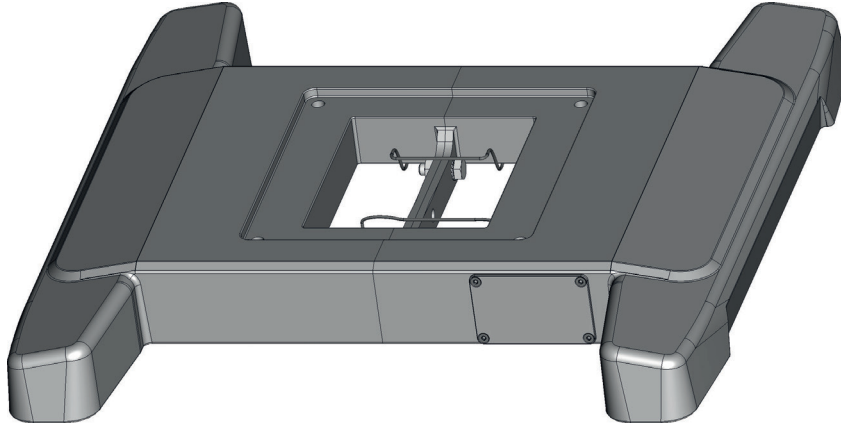
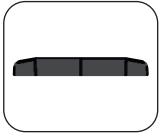

FLEX.BASE
Art.-Nr.:1016552200
RAL 9006

Property chart			
Specification	Value	According to standard	Remark
General data:			
Dimensions (mm)	592 x 592 x 72 mm		
Weight	~ 11 kg		
Protection classes	IP54	EN 60529	
Rated voltage	Max. 400 V (AC) Max. 48 V (DC)		
Protection class	I	EN 61140 / VDE 0140-1	Protection by protective conductor
Temperature range	-5°C bis +70°C		
Material	Enclosure: Alumimium presssure die-casting Lower plate: galvanised steel / Screws: Stainless steel Cover: Aluminium / Screws: galvanized		
Surface:	powder-coated (Standard = RAL 9006)		