

Type ERGO.FLEX 1000/200 STANDING

Article number 1015300298

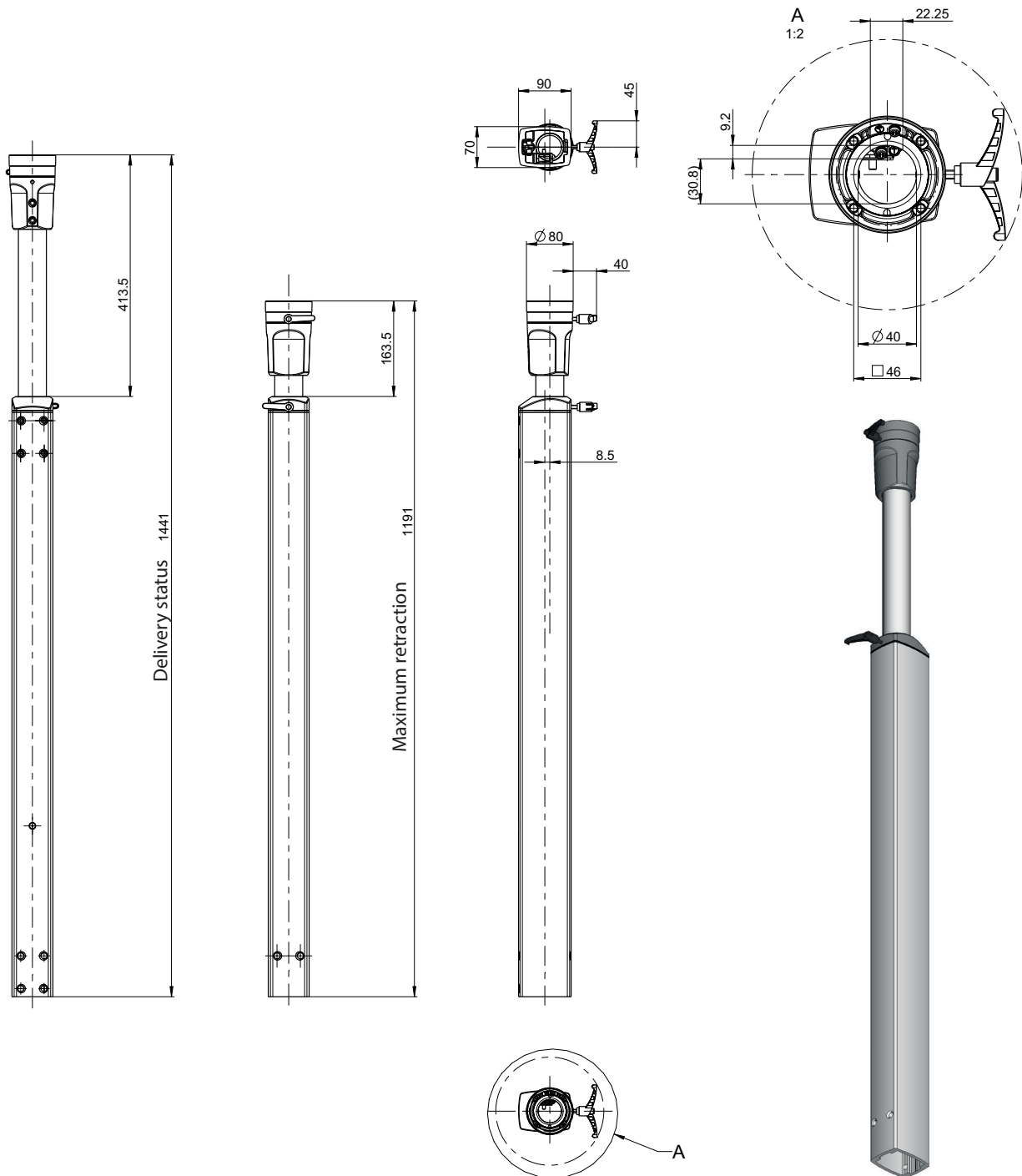

Component pictograms

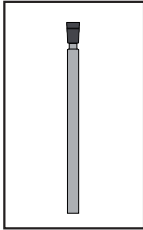

Ergo.FLEX
Art.-Nr.:1015300298
RAL 9006

Property chart			
Specification	Value	According to standard	Remark
General data:			
Dimensions (mm)	1441 x Ø185 mm (retracted, Delivery status)		
Weight	~ 10 kg		
Protection classes	IP 54	EN 60529	
Rated voltage	Max. 400 V (AC) Max. 48 V (DC)		
Protection class	I	EN 61140 / VDE 0140-1	⚡ Protection by protective conductor
Temperature range	-5°C bis +70°C		
gland cross-section	Ø40mm partial area constricted		Details see drawing
Material:	Aluminium (coupling, pipe guide, pipe) Steel (mudguard) Steel tube CR Neoprene (gasket) POM (plastic parts)		
Surface:	Powder-coated RAL9006 (coupling, pipe guide) Anodised natural (tube) Galvanised (tubular steel)		
Gas spring:	Power 200N, stroke 250mm		
Use:	IPCs and small control boxes up to 18 kg		
Cable guide:	by energy chain (drag chain)		