

DECKEL/LID/COUVERCLE

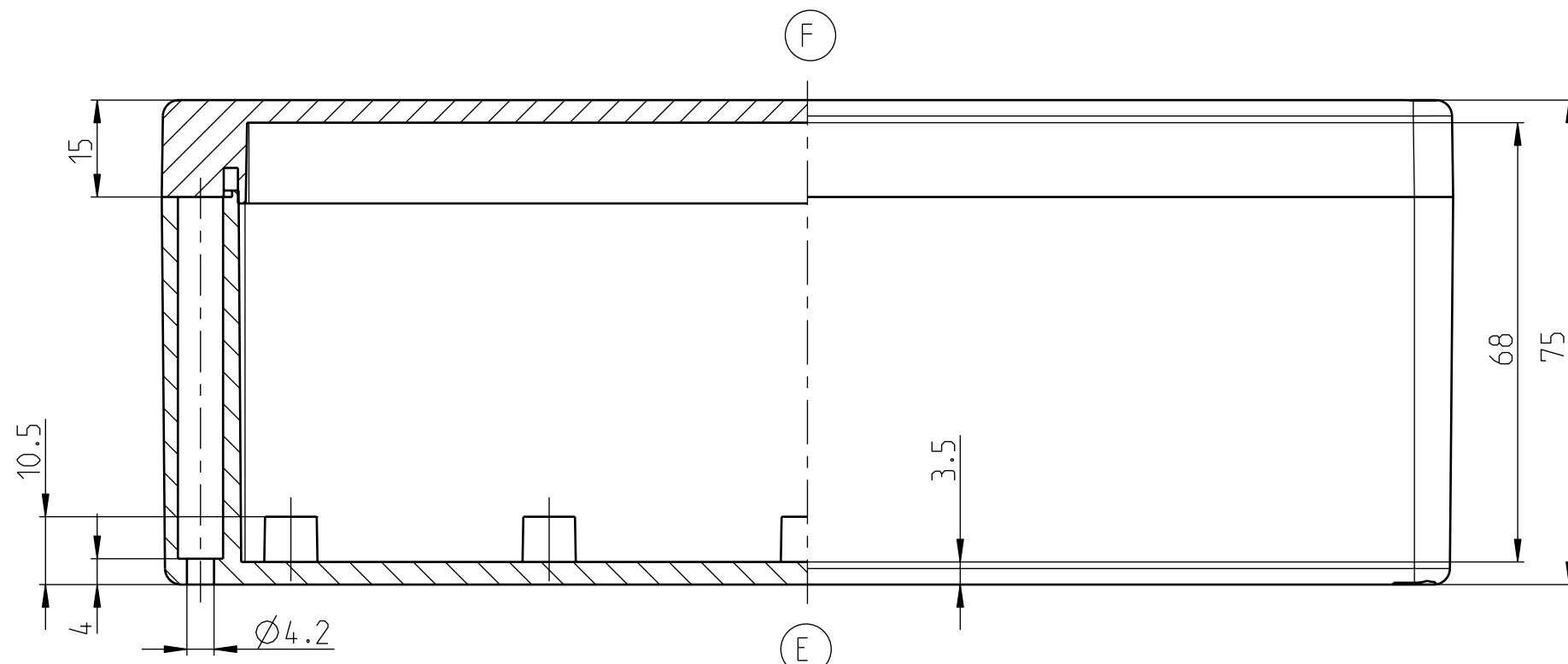

UNTERTEIL/BASE/PARTIE BASSE

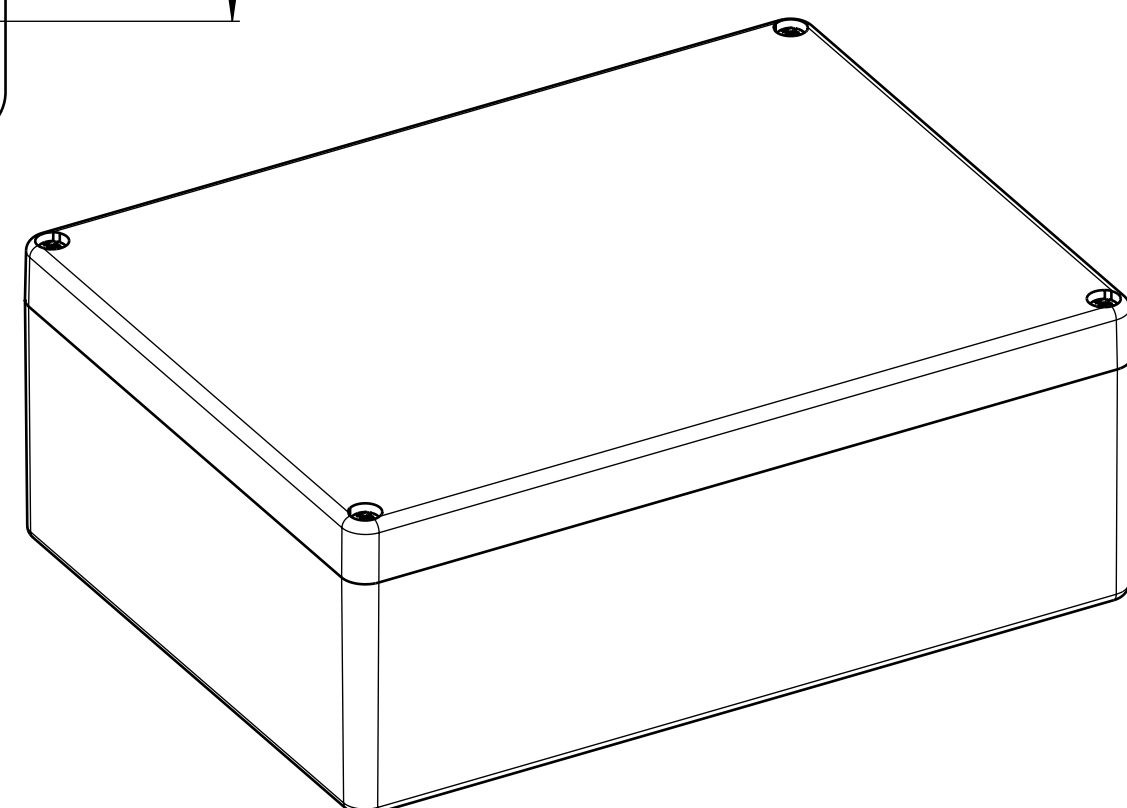
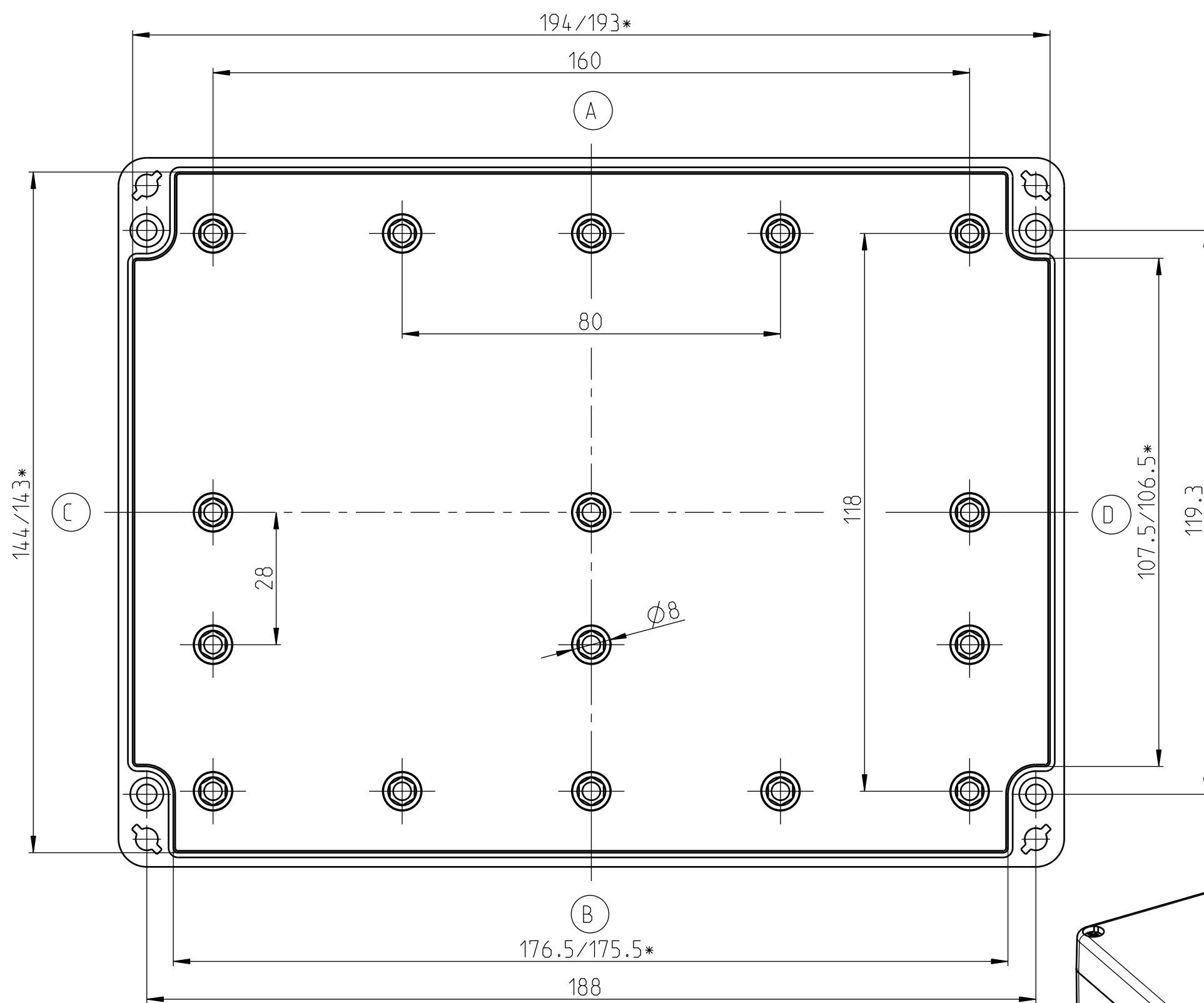

200x150x75  
 CT-821 Polycarbonatgehäuse  
 CT-822 ABS-Gehäuse  
 erstellt am 02.02.2011 / K.Herd  
 Eigentum der Bernstein AG

\* Kleineres Maß in Höhe der Montageplatteauflage