

DECKEL/LID/COUVERCLE

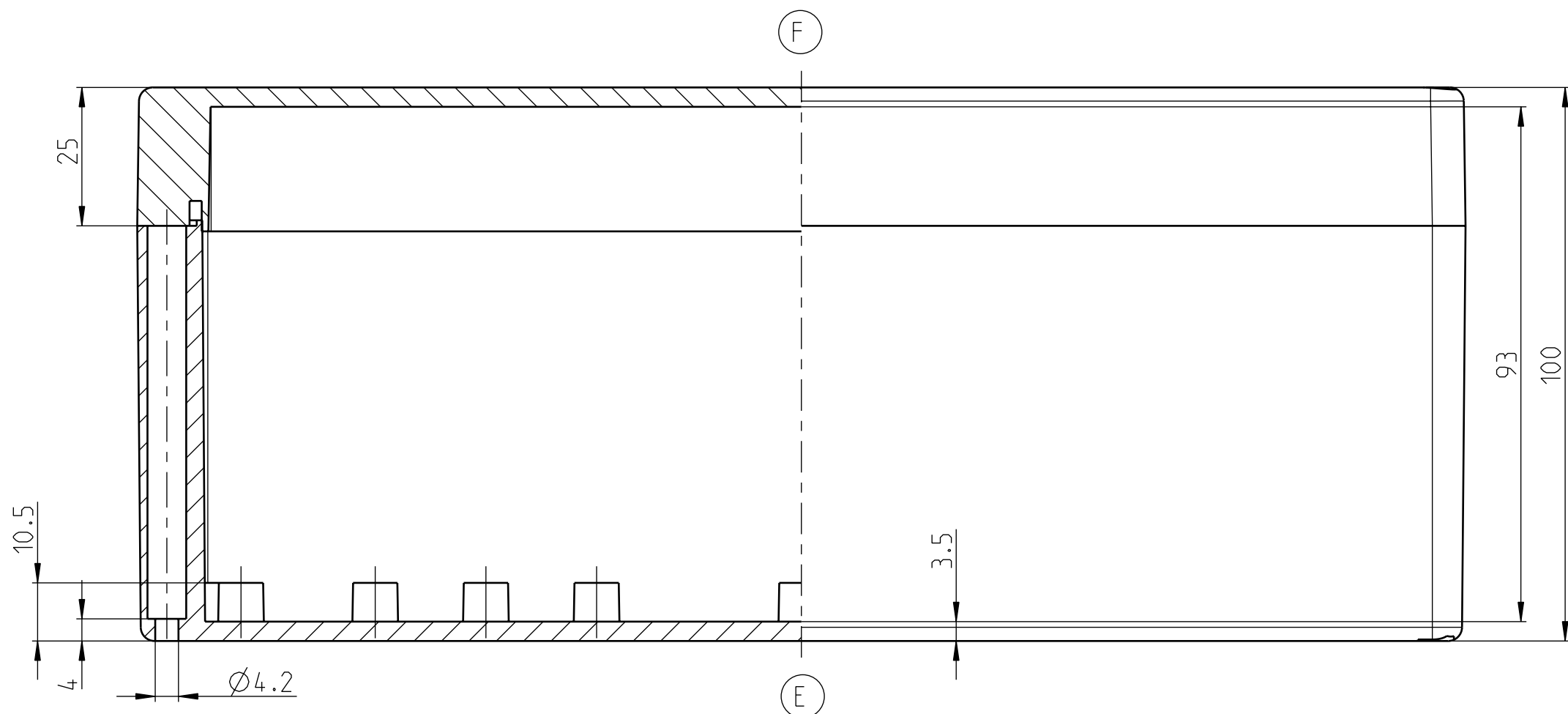

UNTERTEIL/BASE/PARTIE BASSE

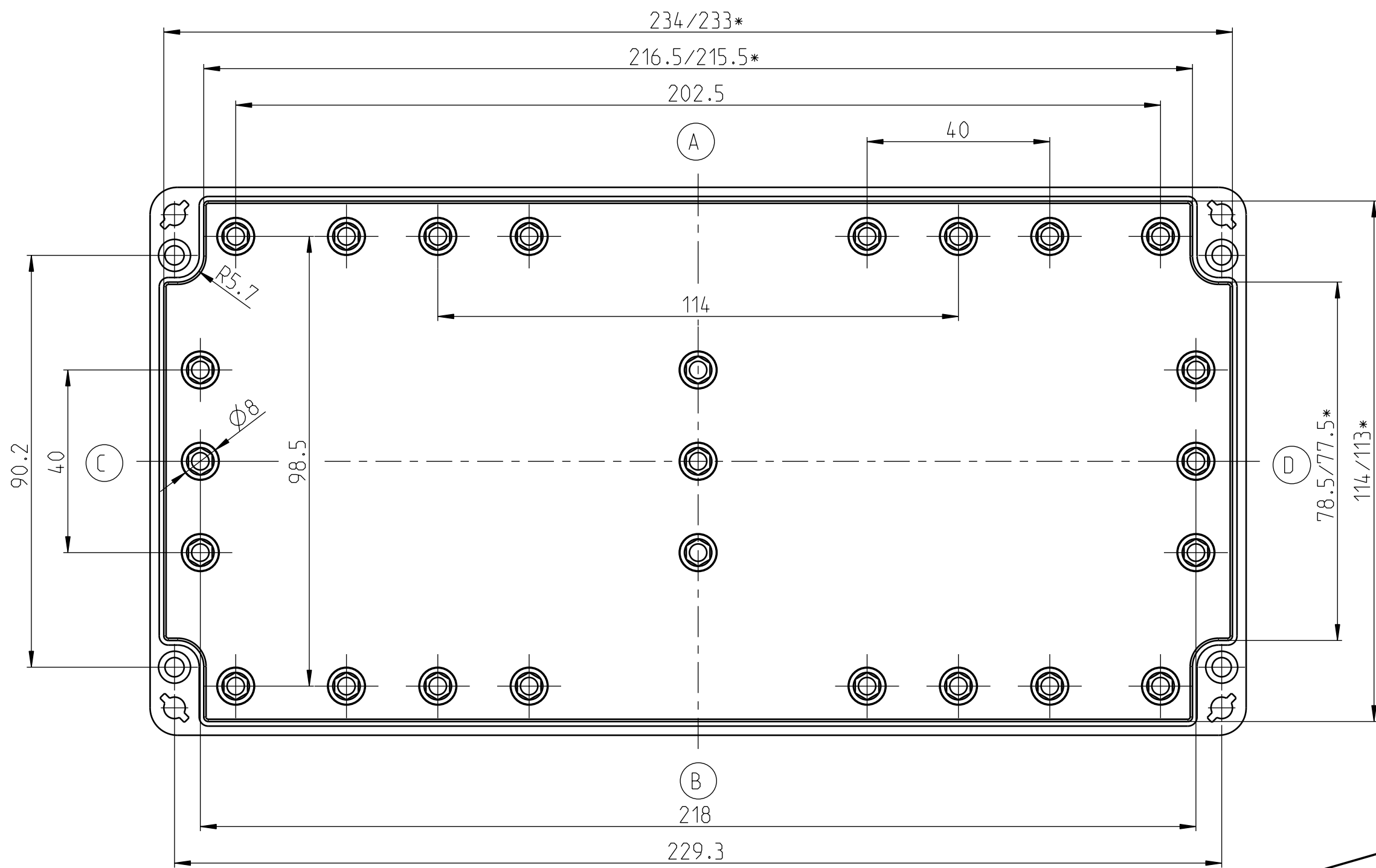

240x120x100
 CT-801 Polycarbonatgehäuse
 CT-802 ABS-Gehäuse
 erstellt am 02.02.2011 / K.Herd
 Eigentum der Bernstein AG

* Kleineres Maß in Höhe der Montageplatteauflage

