

DECKEL/LID/COUVERCLE

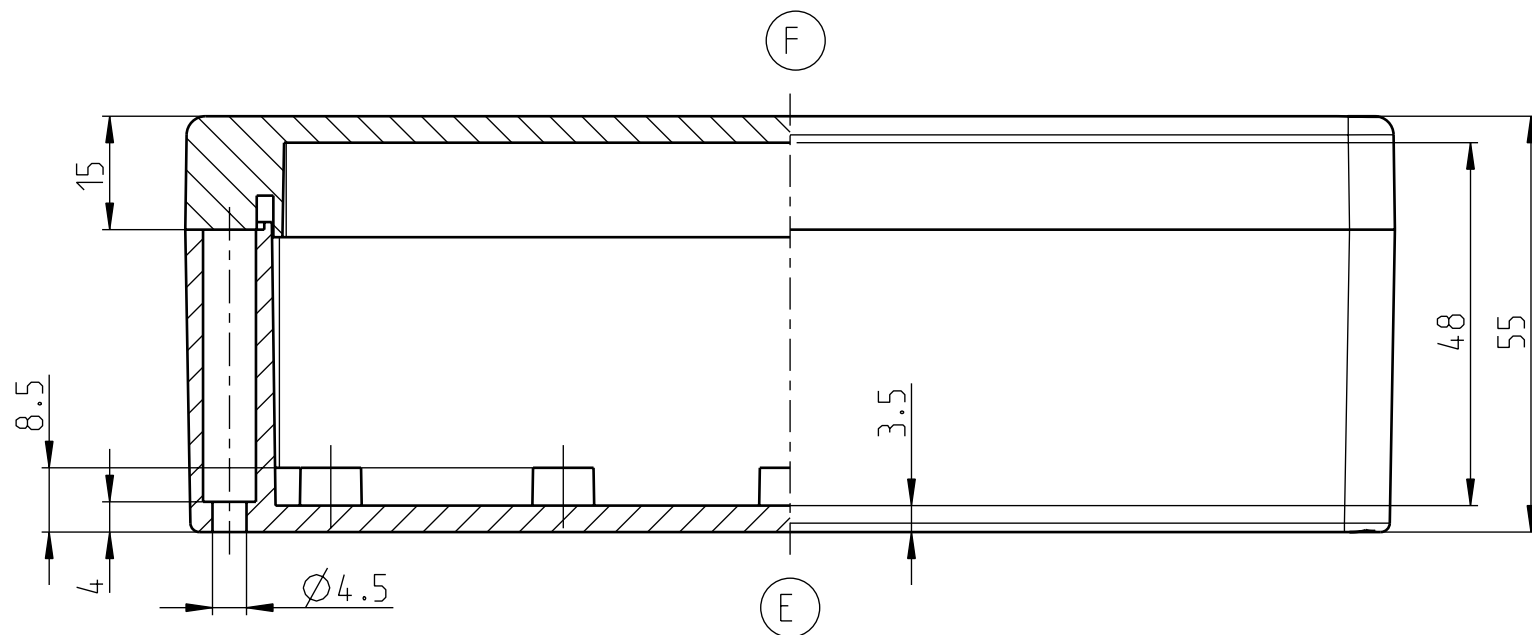

UNTERTEIL/BASE/PARTIE BASSE

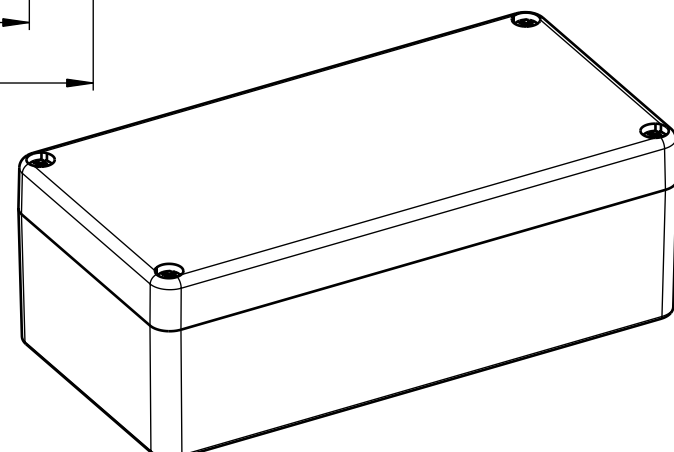
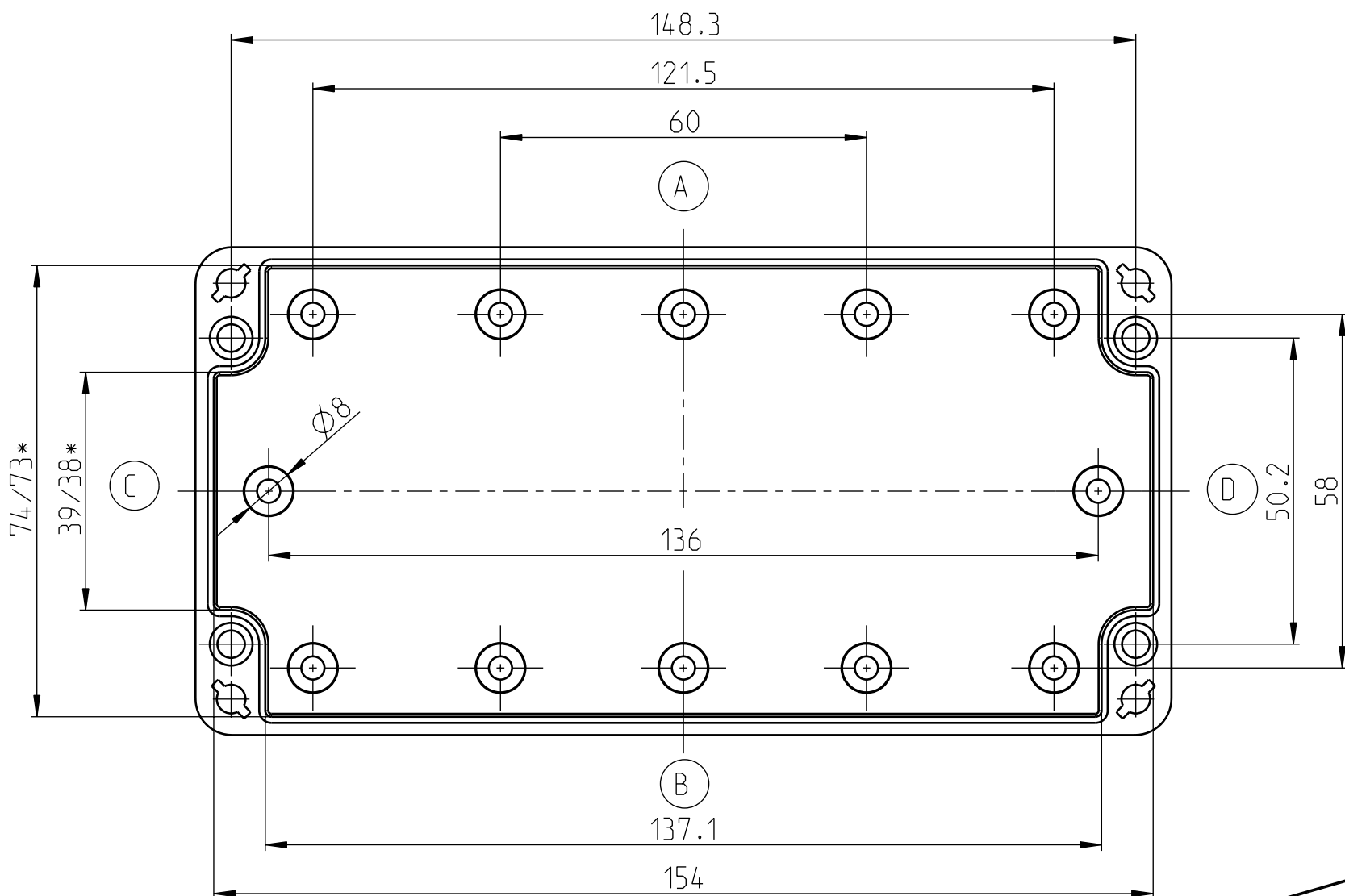

160x80x55  
 CT-621 Polycarbonatgehäuse  
 CT-622 ABS-Gehäuse  
 erstellt am 31.01.2011 / K.Herd  
 Eigentum der Bernstein AG

\* Kleineres Maß in Höhe der Montageplatteauflage