

DECKEL/LID/COUVERCLE

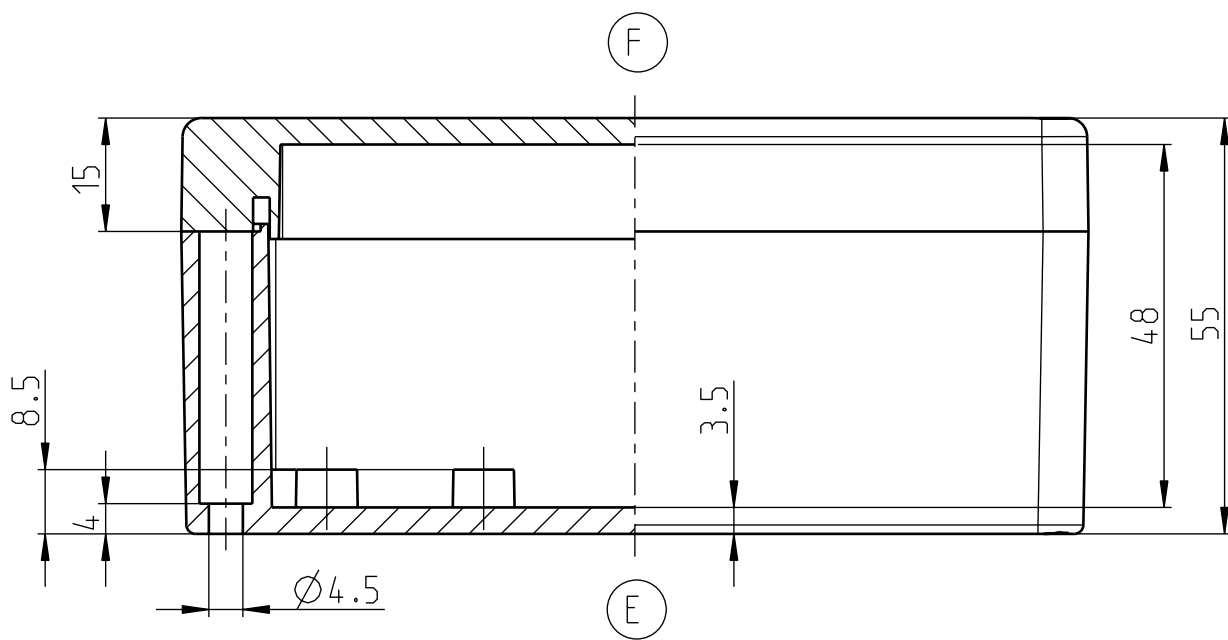

UNTERTEIL/BASE/PARTIE BASSE

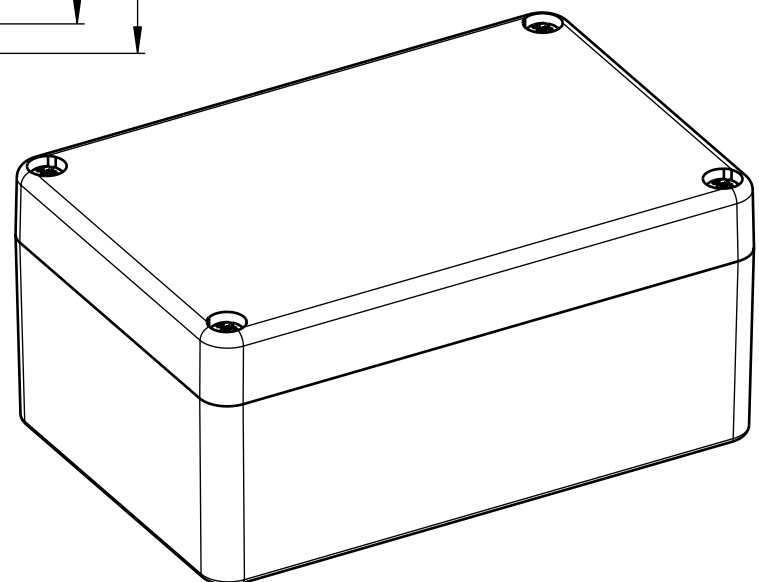
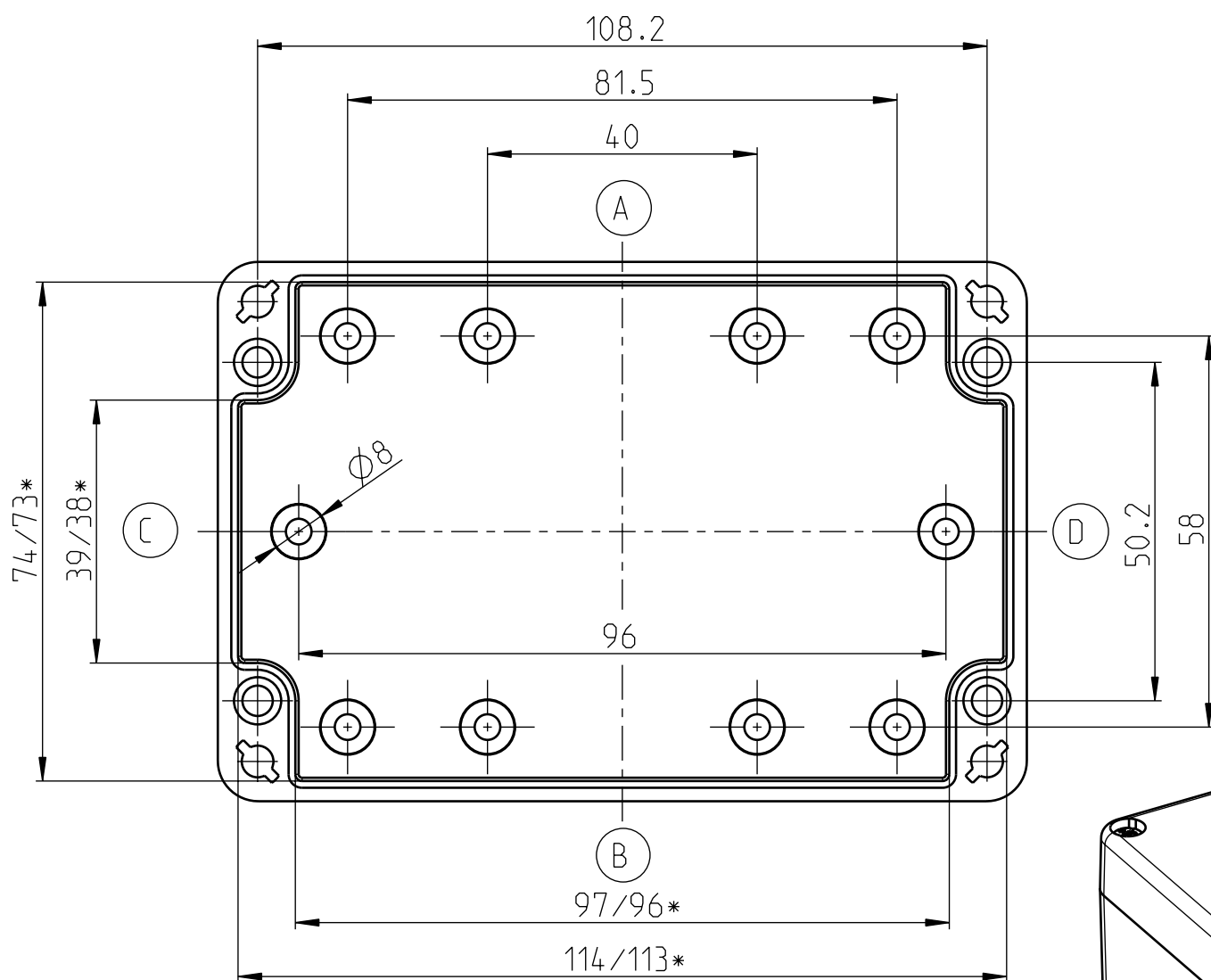

120x80x55
 CT-581 Polycarbonatgehäuse
 CT-582 ABS-Gehäuse
 erstellt am 31.01.2011 / K.Herd
 Eigentum der Bernstein AG

* Kleineres Maß in Höhe der Montageplatteauflage