

DECKEL/LID/COUVERCLE

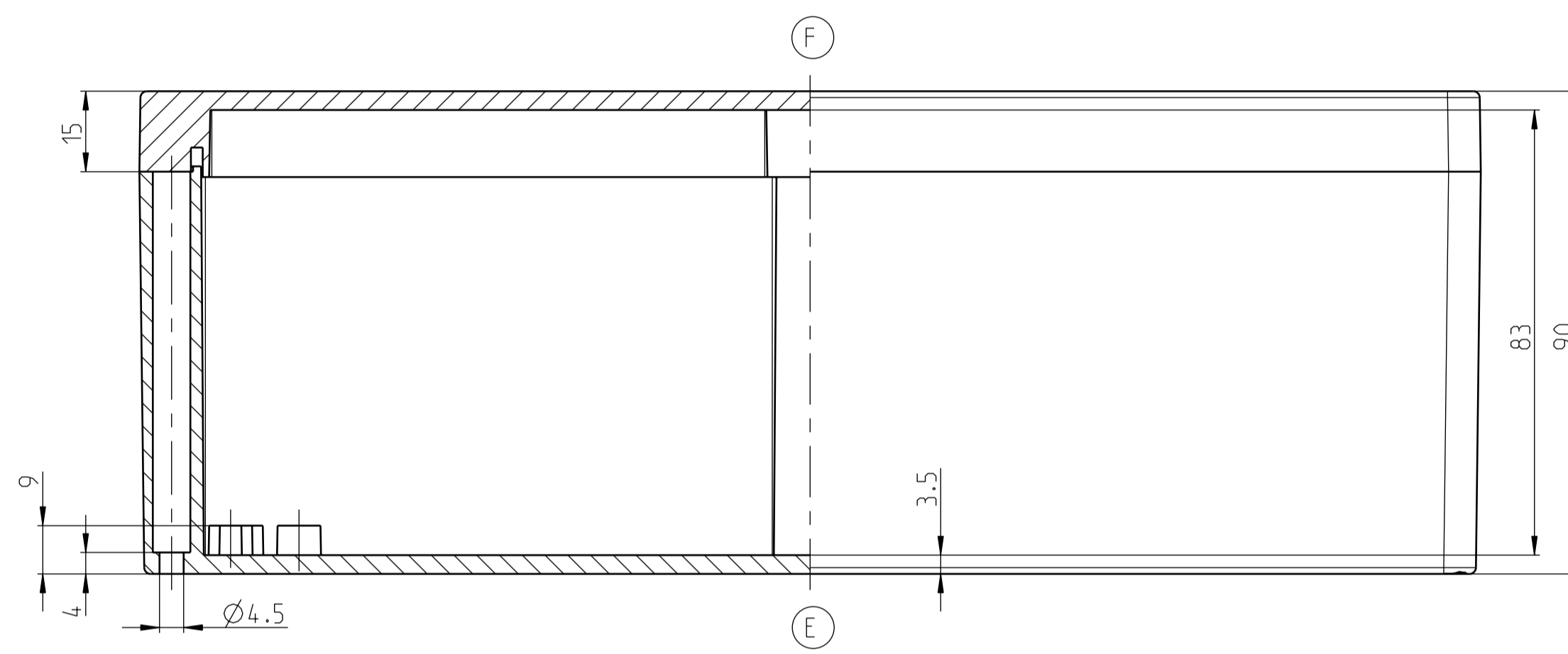

UNTERTEIL/BASE/PARTIE BASSE

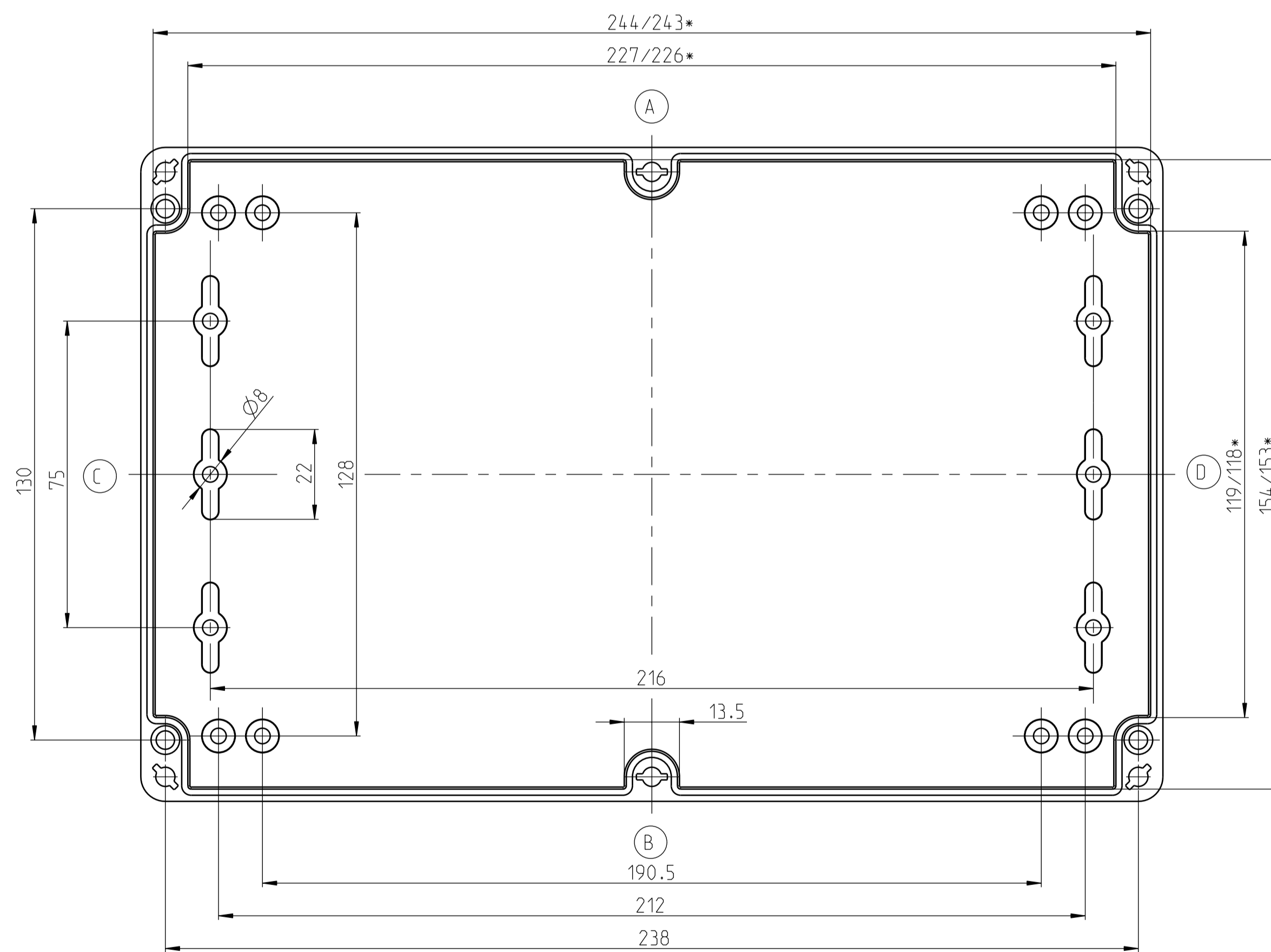

250x160x90
 CT-901 Polycarbonatgehäuse
 CT-902 ABS-Gehäuse
 erstellt am 02.02.2011 / K.Herd
 Eigentum der Bernstein AG

* Kleineres Maß in Höhe der Montageplatteauflage