

DECKEL/LID/COUVERCLE

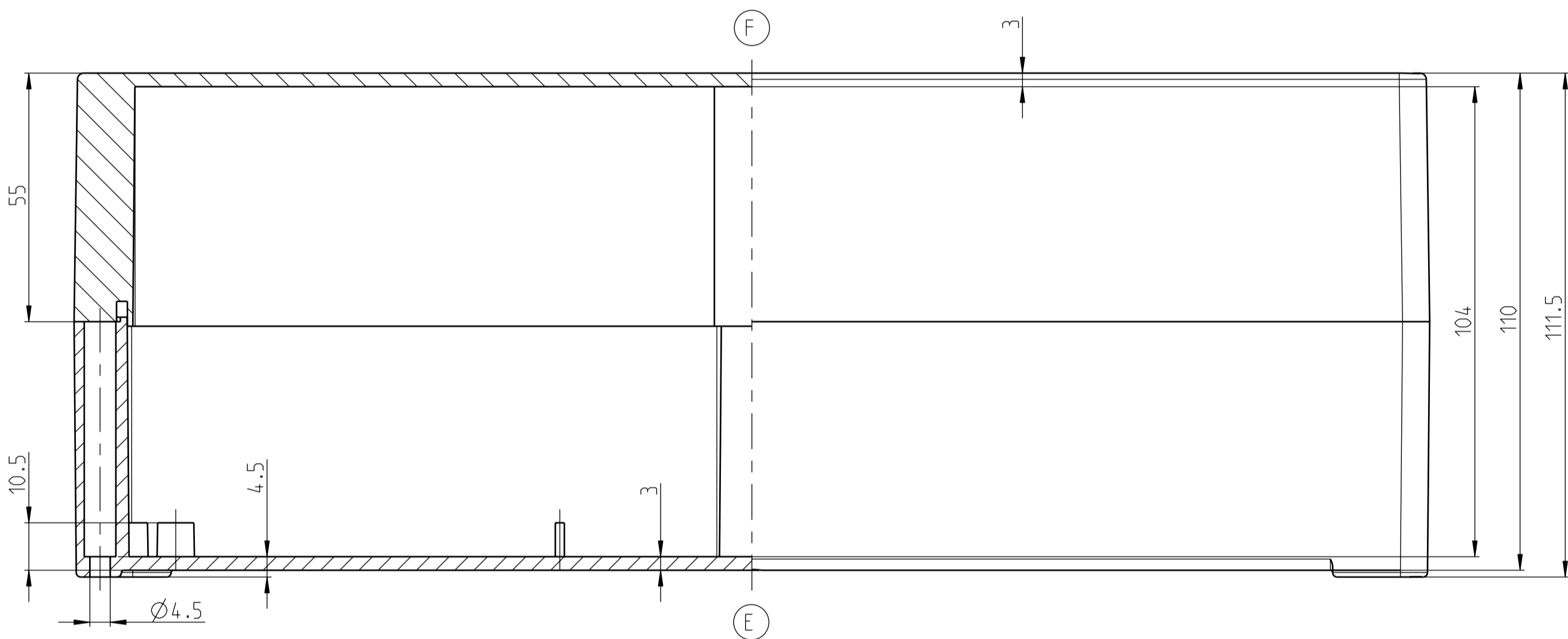

UNTERTEIL/BASE/PARTIE BASSE

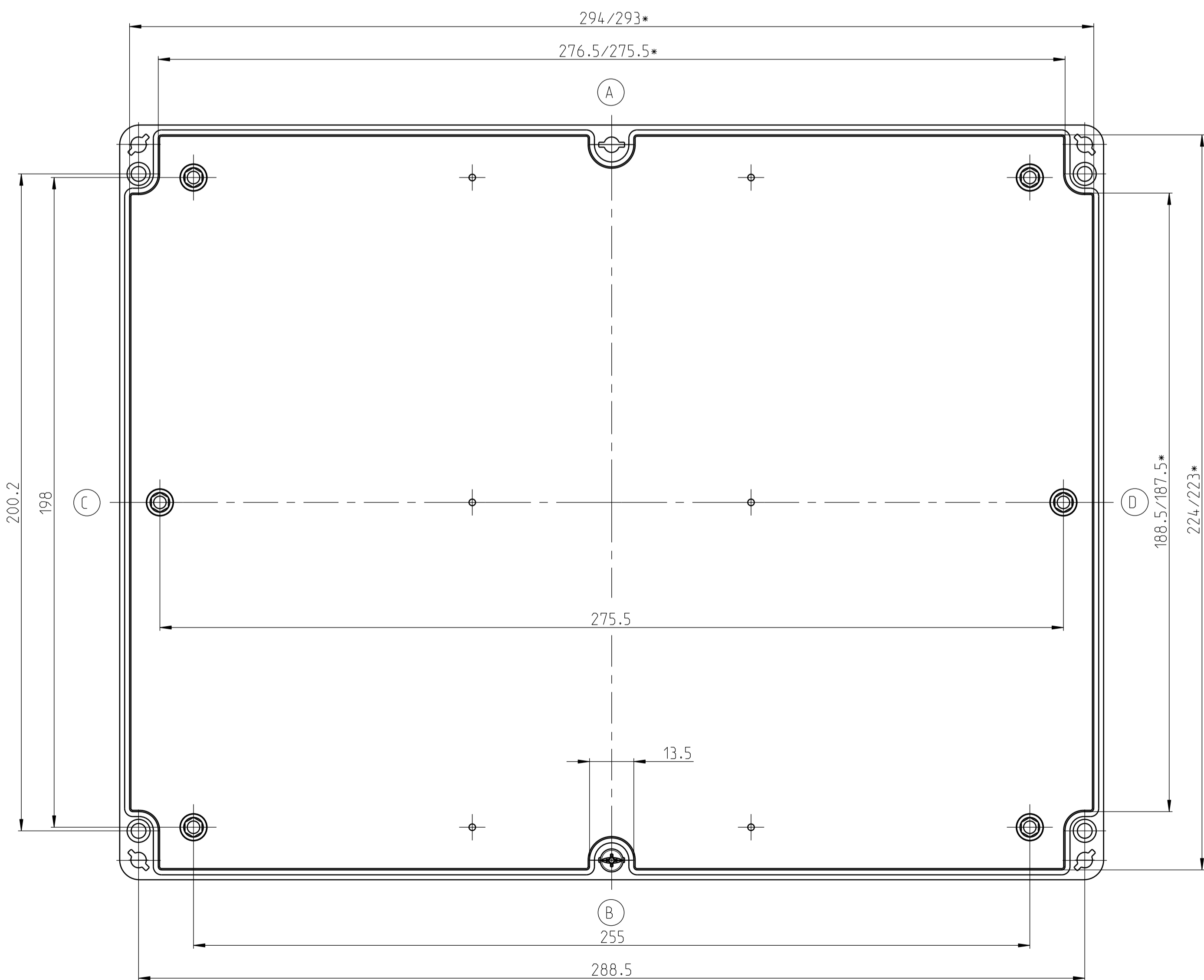

300x230x110
 CT-891 Polycarbonatgehäuse
 CT-892 ABS-Gehäuse
 erstellt am 03.02.2011 / K.Herd
 Eigentum der Bernstein AG

* Kleineres Maß in Höhe der Montageplatteauflage

