

DECKEL/LID/COUVERCLE

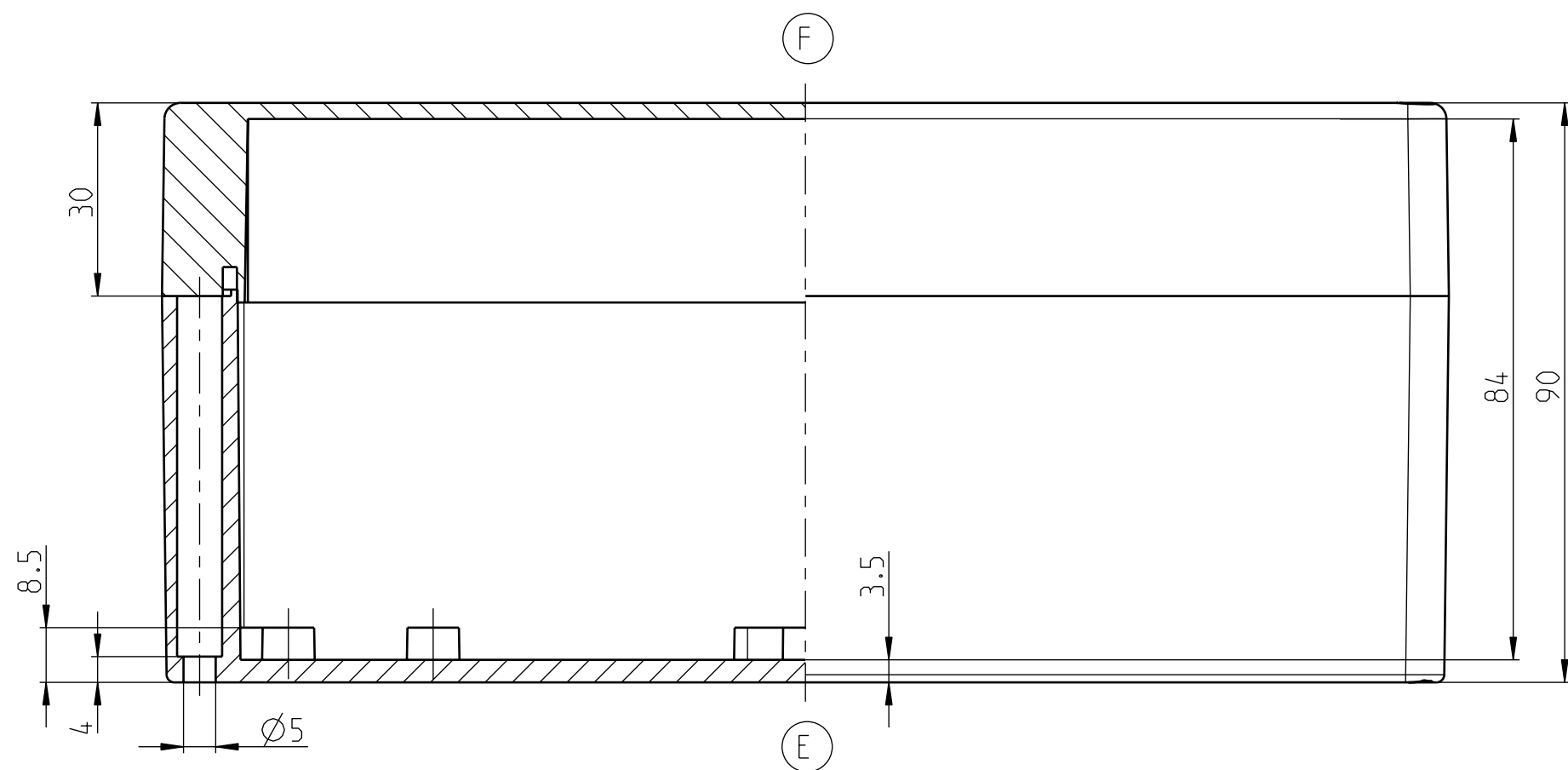

UNTERTEIL/BASE/PARTIE BASSE

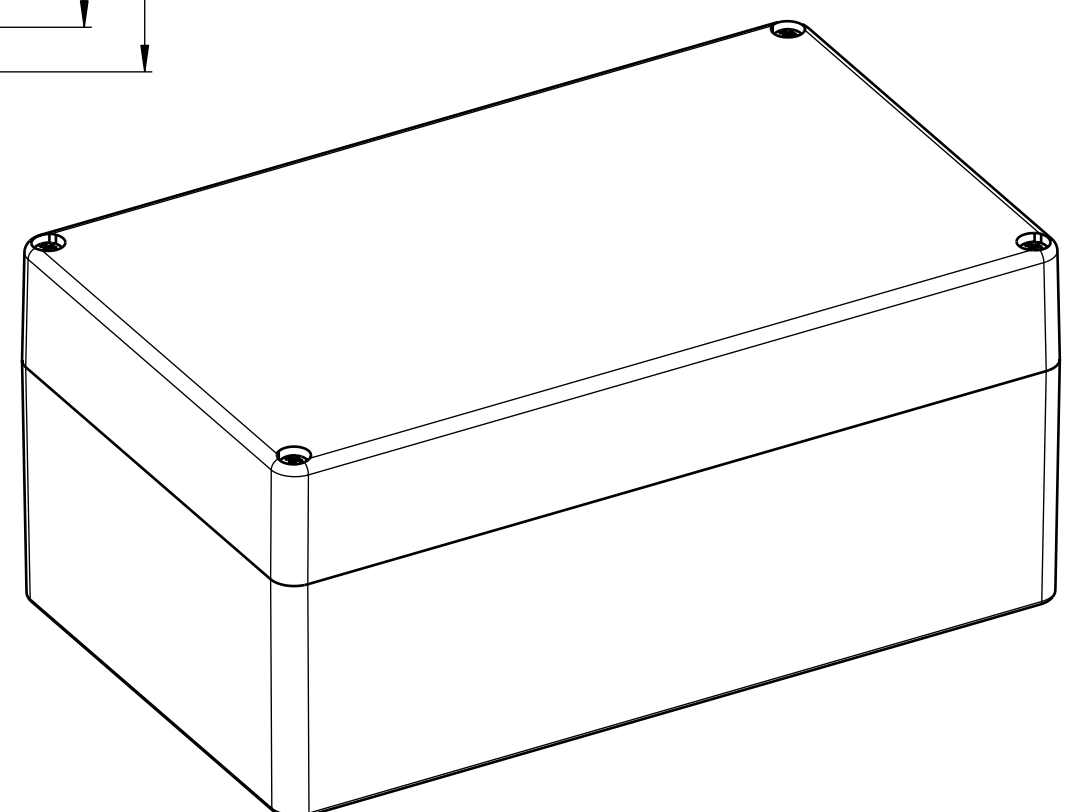
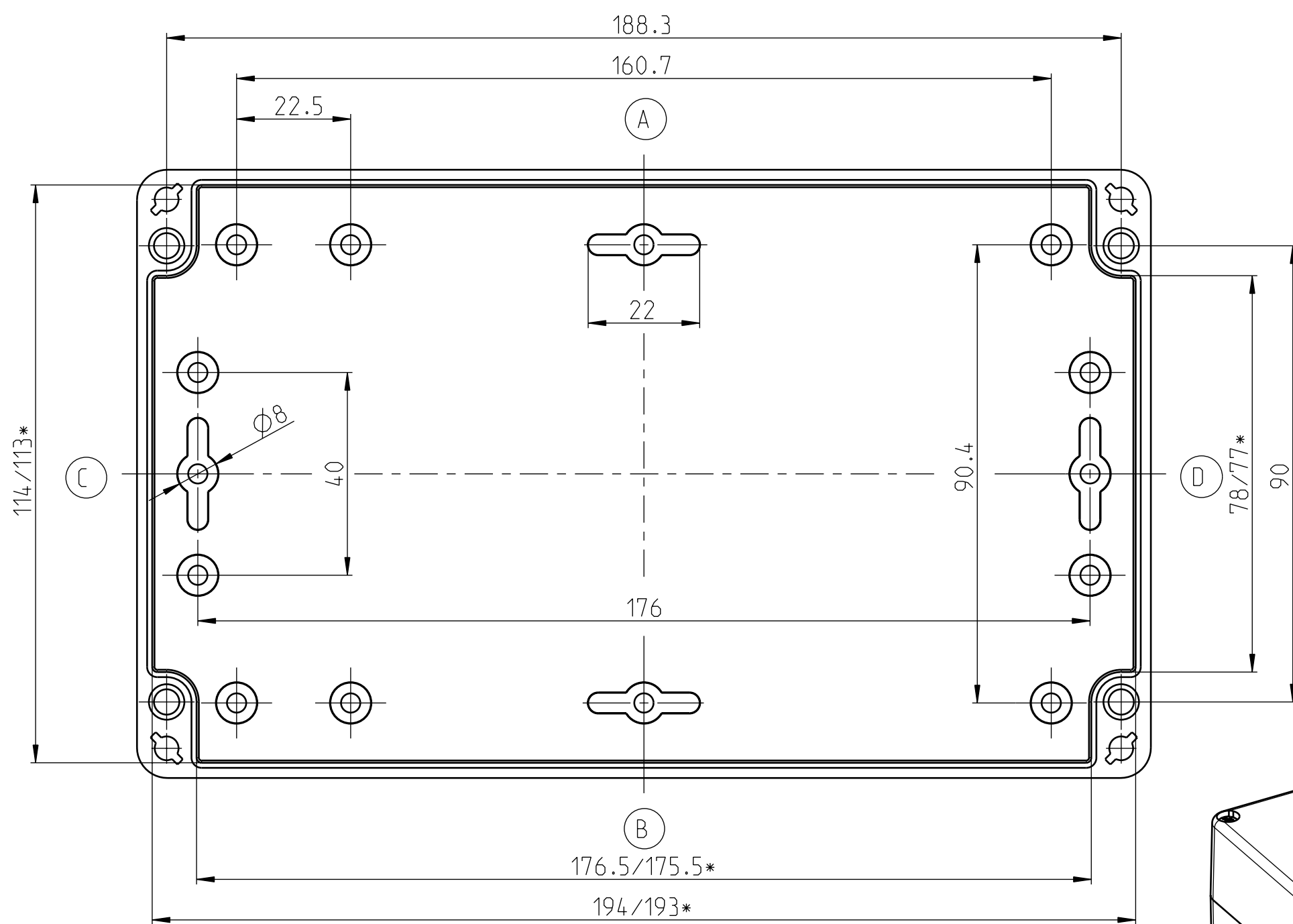

200x120x90
 CT-781 Polycarbonatgehäuse
 CT-782 ABS-Gehäuse
 erstellt am 02.02.2010 / K.Herd
 Eigentum der Bernstein AG

* Kleineres Maß in Höhe der Montageplatteauflage