

DECKEL/LID/COUVERCLE

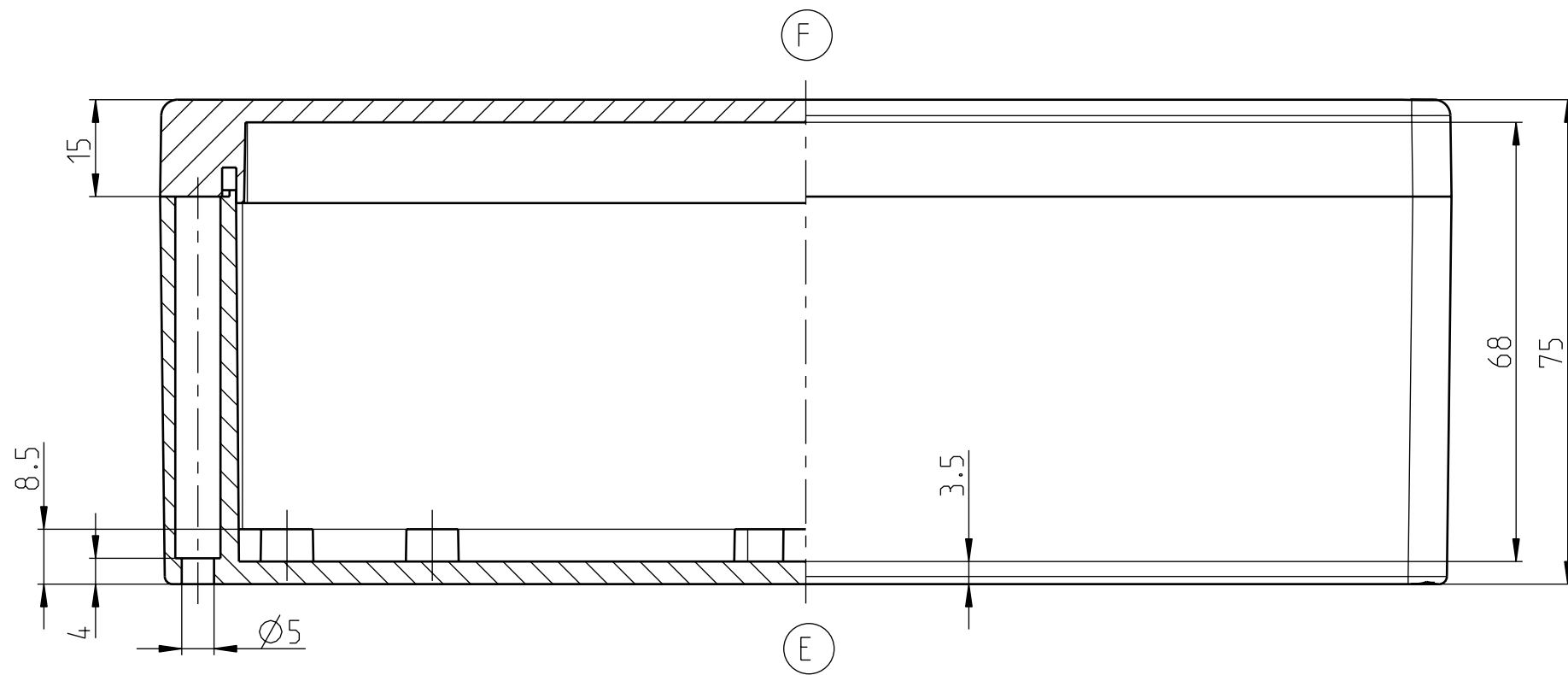

UNTERTEIL/BASE/PARTIE BASSE

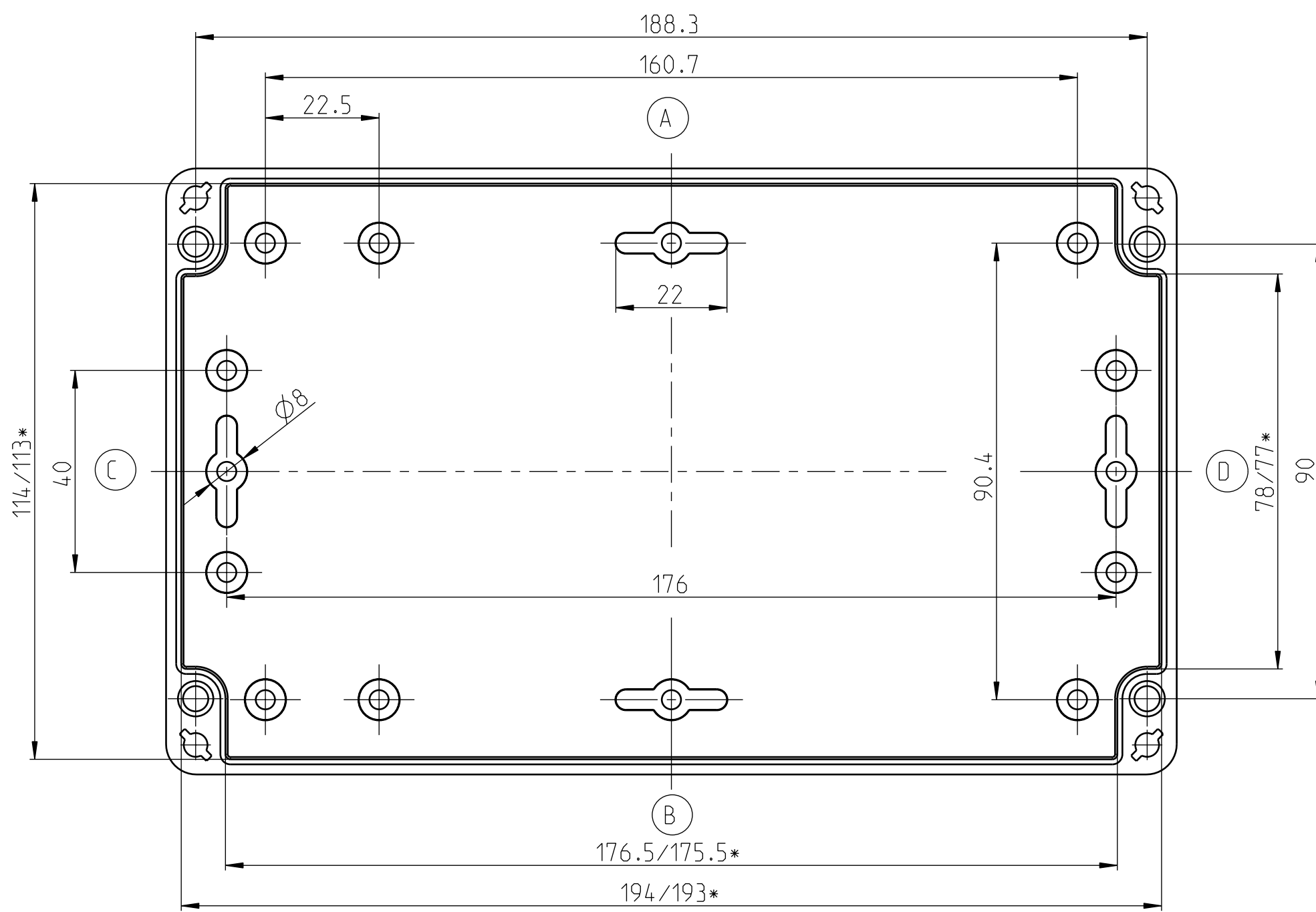

200x120x75
 CT-761 Polycarbonatgehäuse
 CT-762 ABS-Gehäuse
 erstellt am 01.02.2011 / K.Herd
 Eigentum der Bernstein AG

* Kleineres Maß in Höhe der Montageplatteauflage

