

DECKEL/LID/COUVERCLE

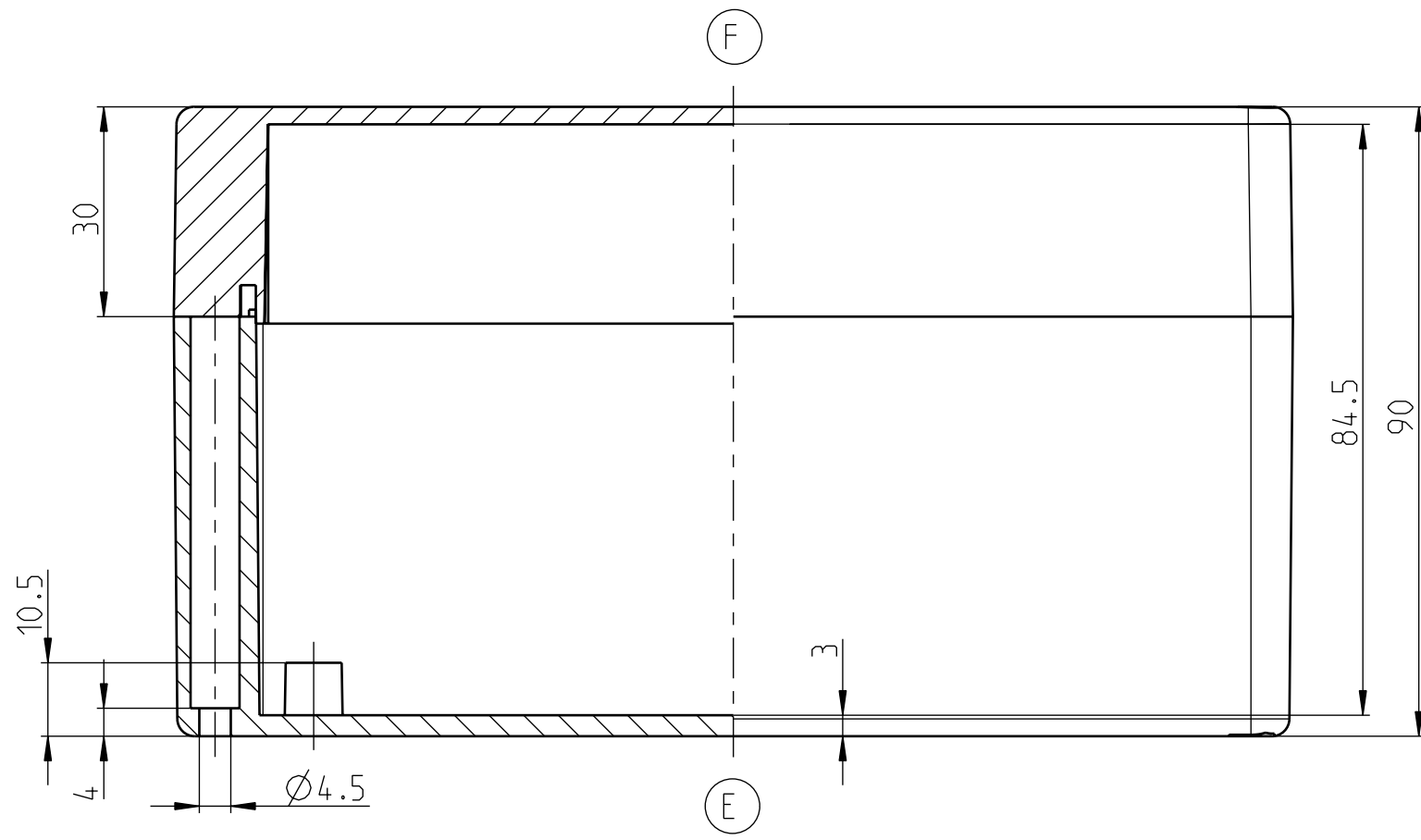

UNTERTEIL/BASE/PARTIE BASSE

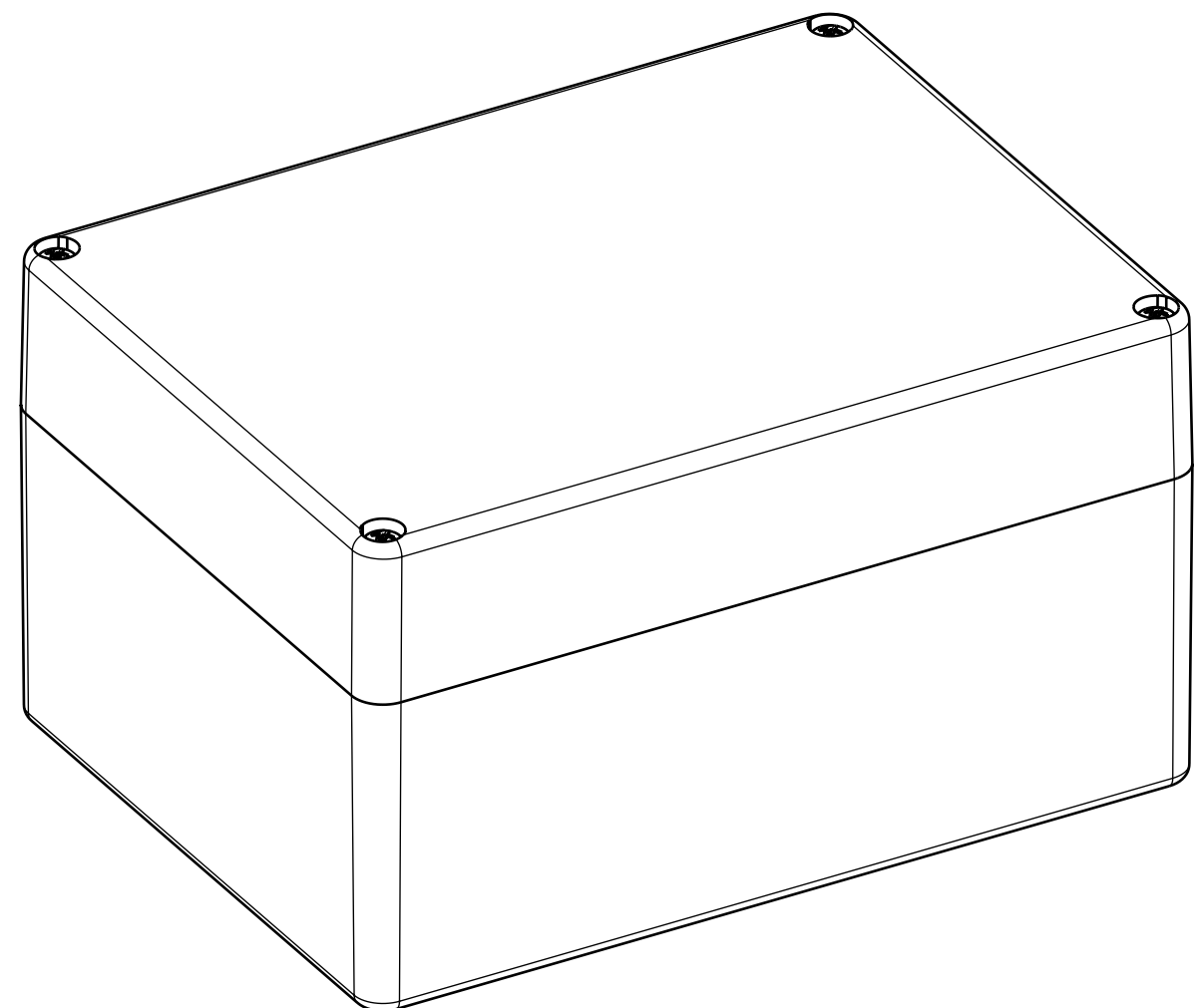
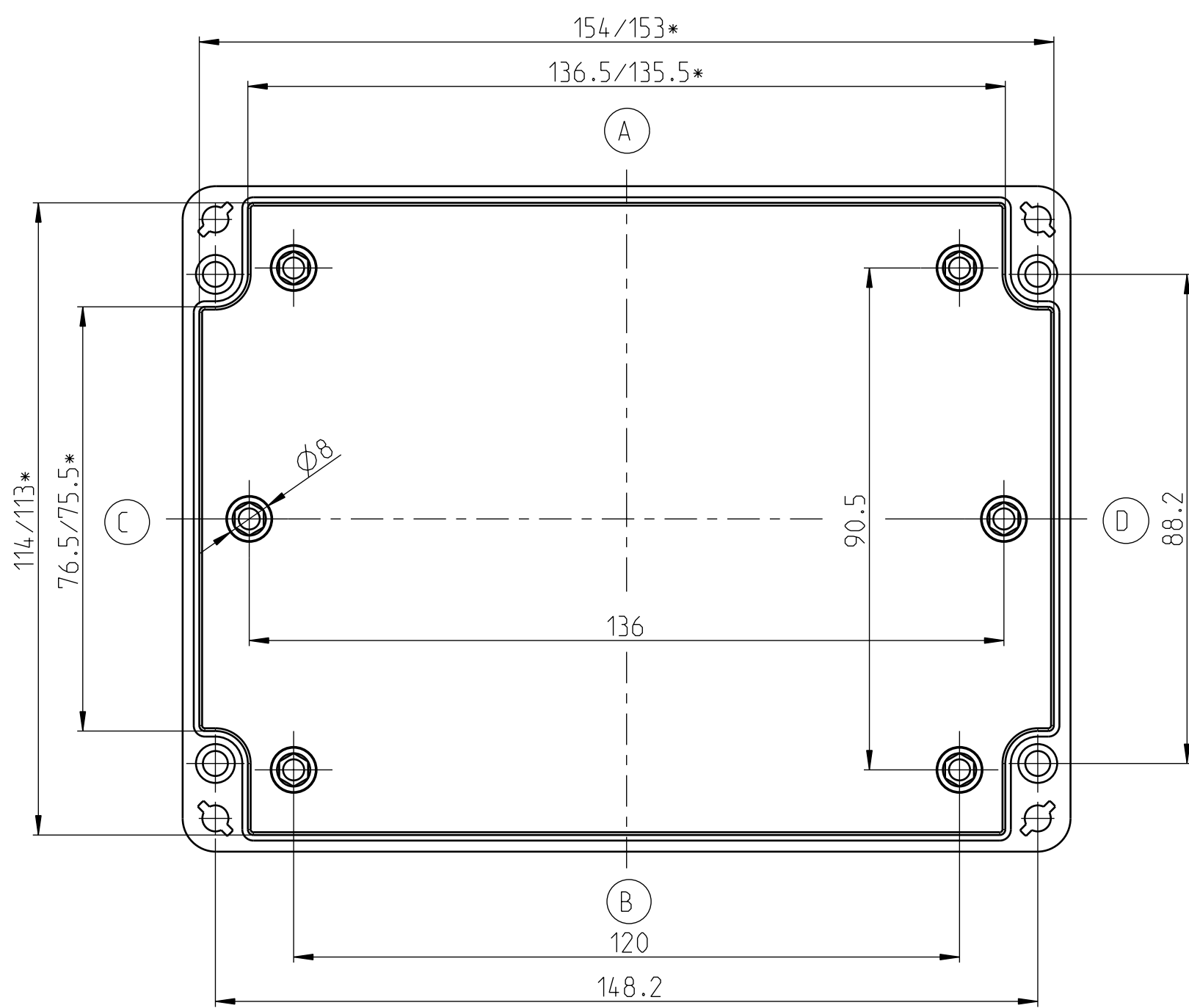

160x120x90
 CT-721 Polycarbonatgehäuse
 CT-722 ABS-Gehäuse
 erstellt am 01.02.2011 / K.Herd
 Eigentum der Bernstein AG

* Kleineres Maß in Höhe der Montageplatteauflage