

DECKEL/LID/COUVERCLE

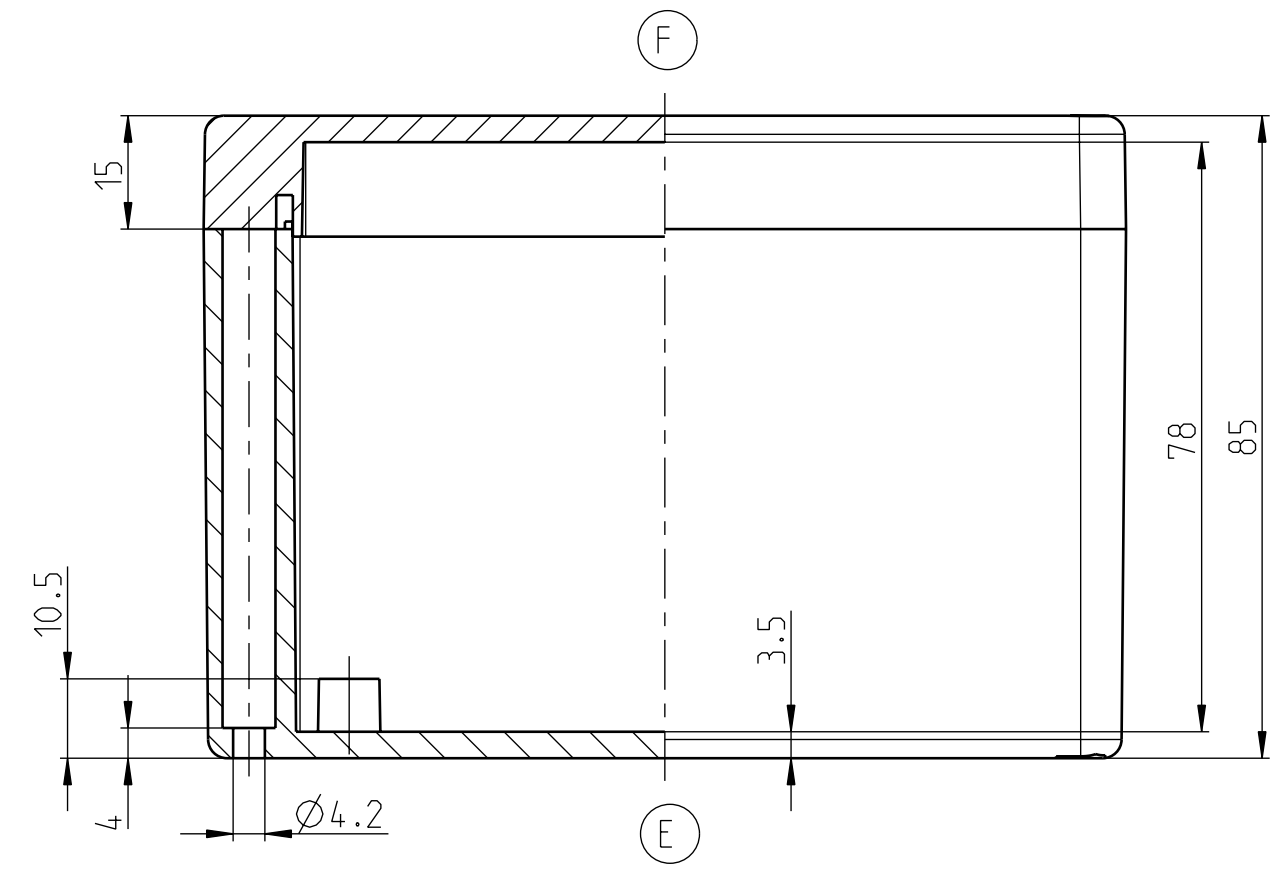

UNTERTEIL/BASE/PARTIE BASSE

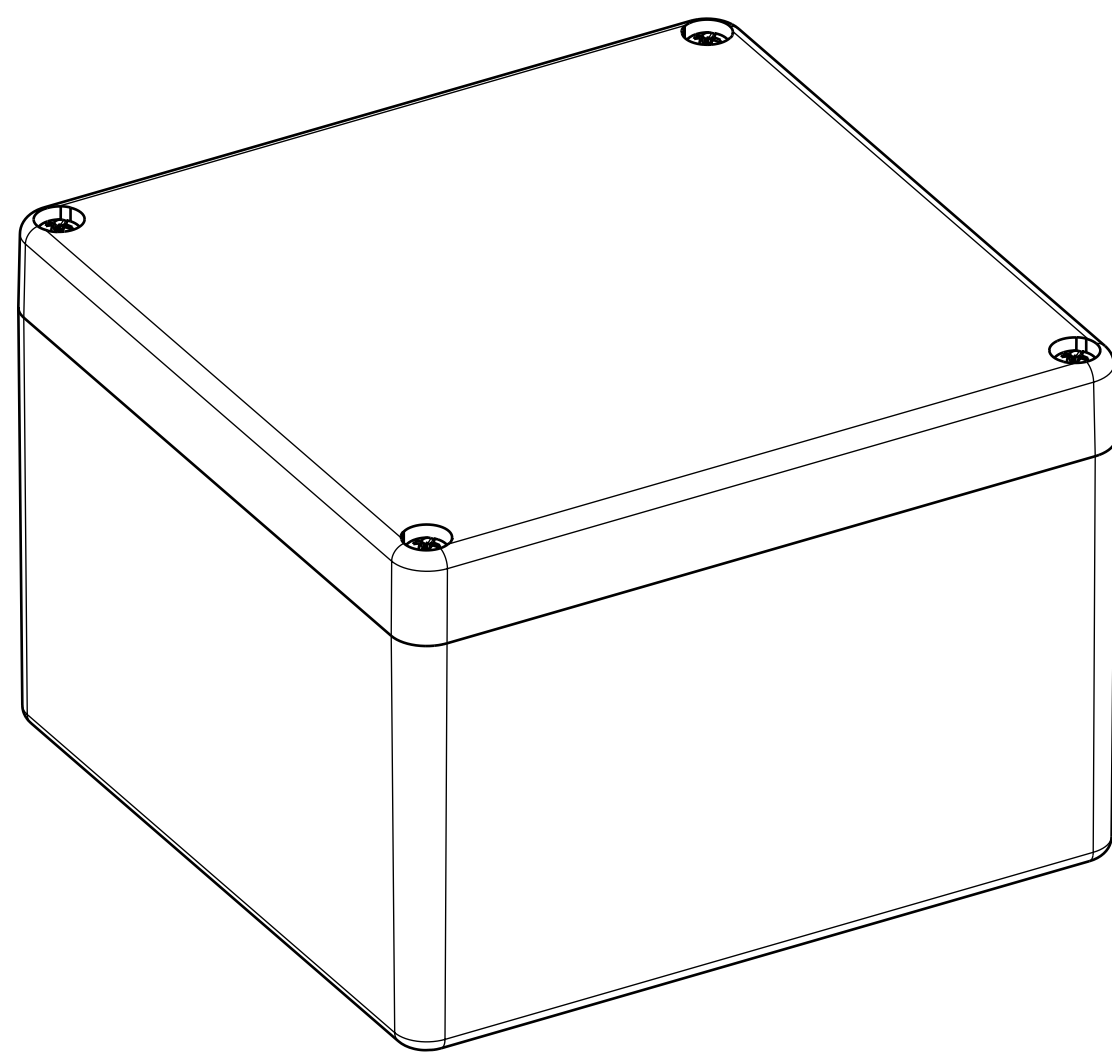
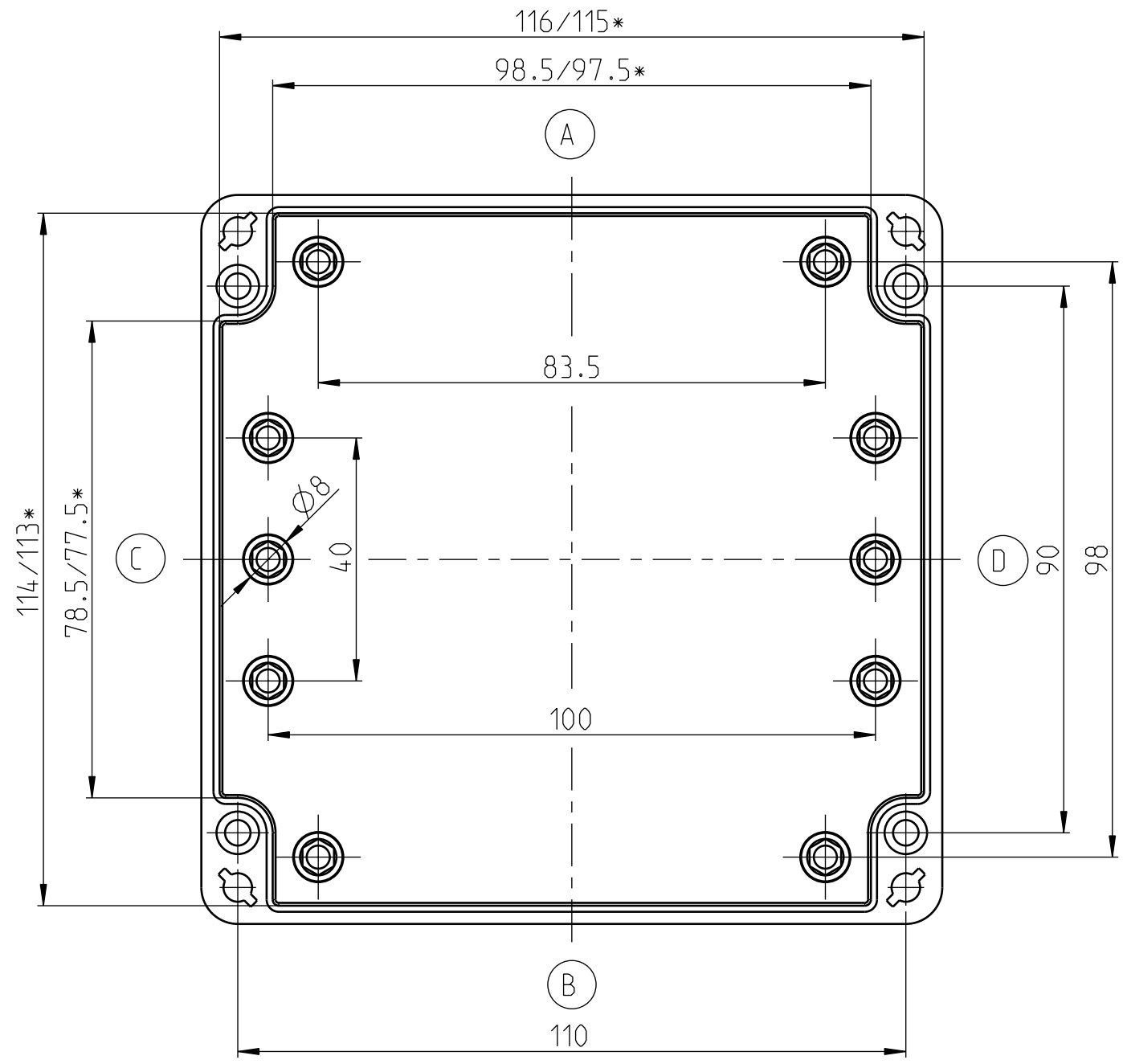

122x120x85
 CT-681 Polycarbonatgehäuse
 CT-682 ABS-Gehäuse
 erstellt am 01.02.2011 / K.Herd
 Eigentum der Bernstein AG

* Kleineres Maß in Höhe der Montageplatteauflage