

DECKEL/LID/COUVERCLE

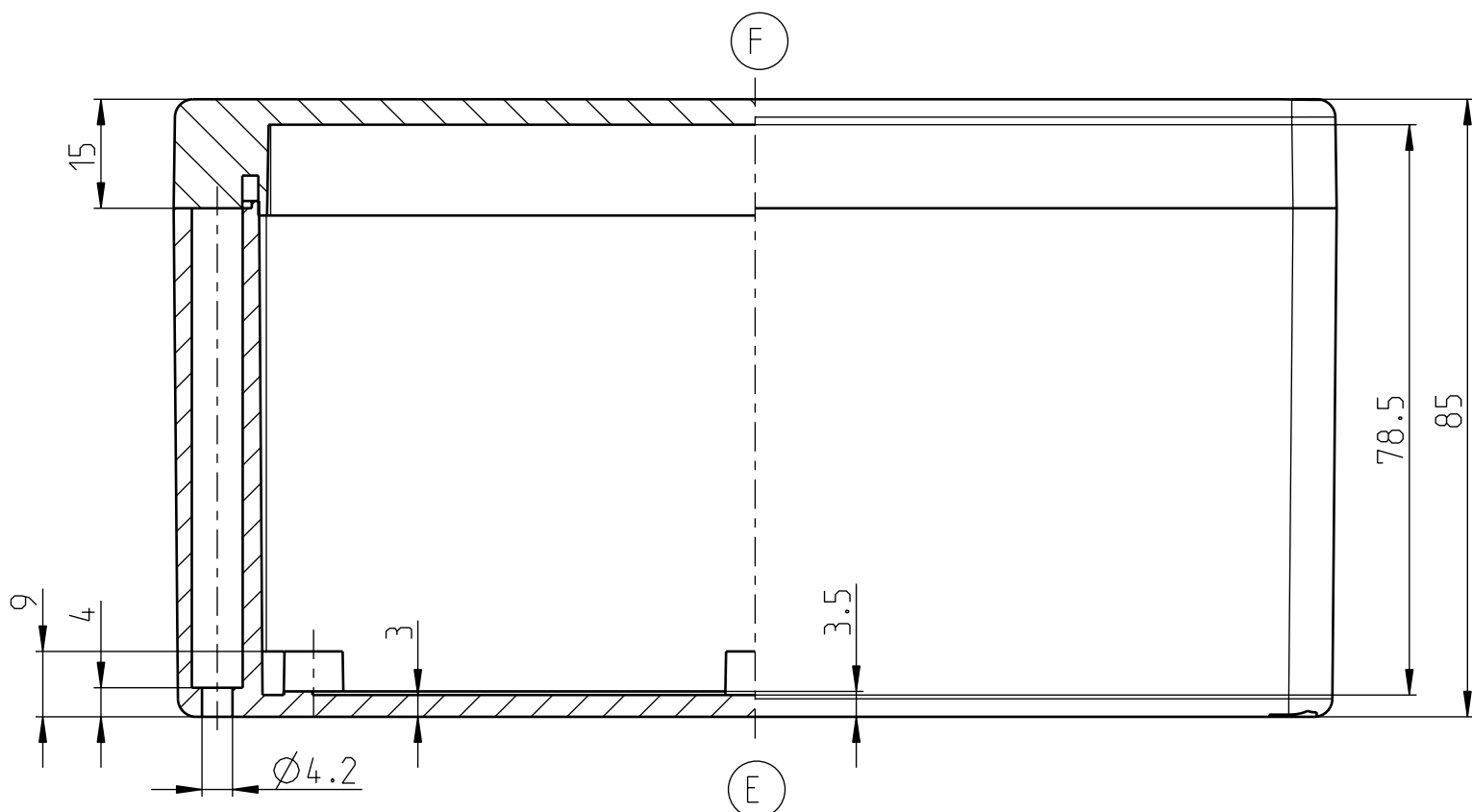

UNTERTEIL/BASE/PARTIE BASSE

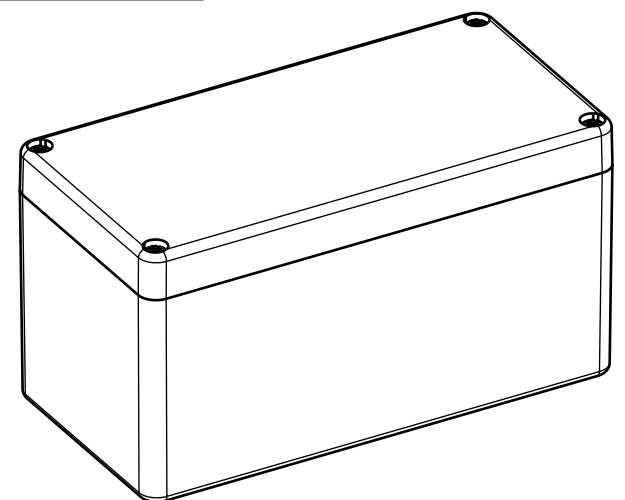
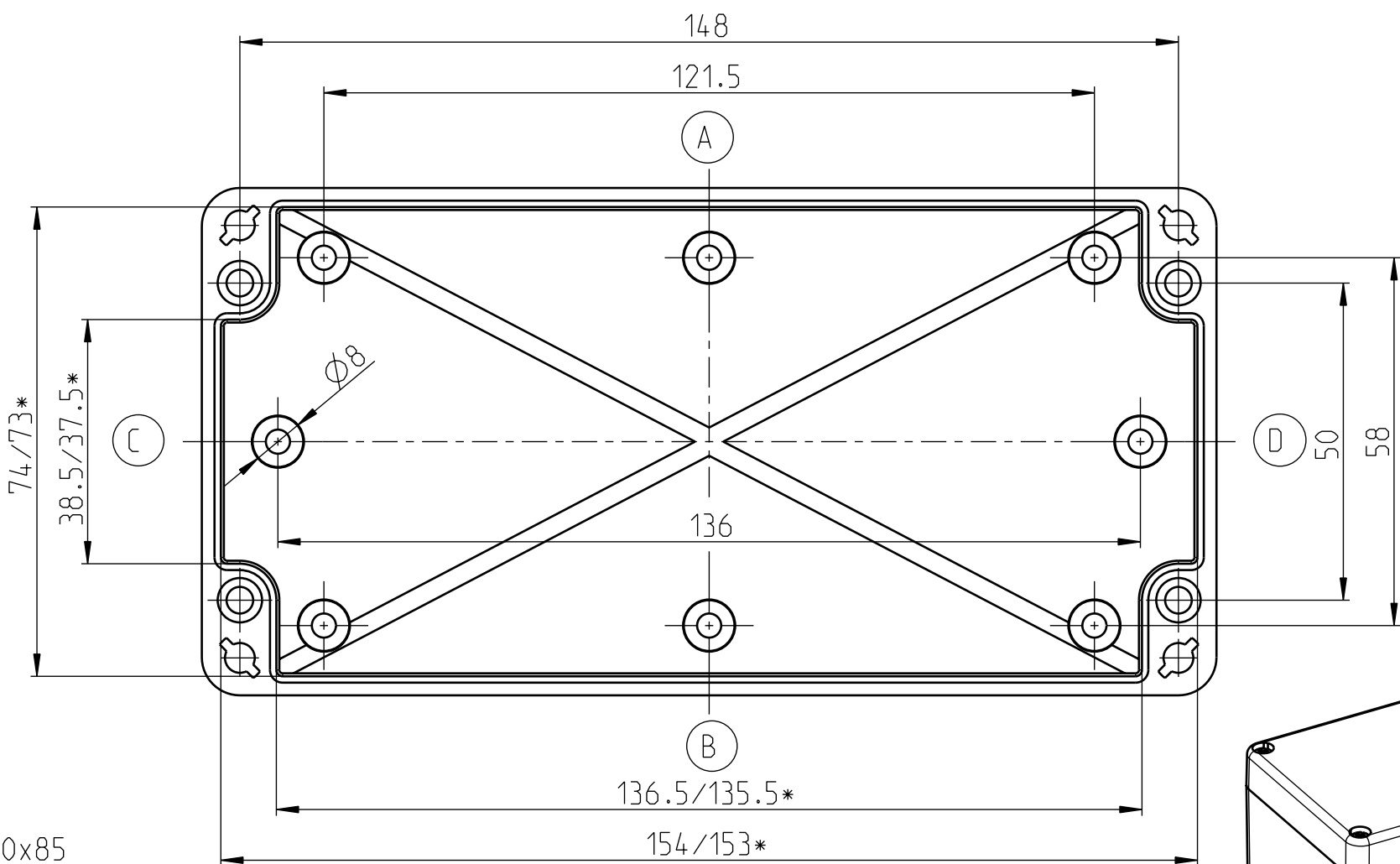

160x80x85  
 CT-641 Polycarbonatgehäuse  
 CT-642 ABS-Gehäuse  
 erstellt am 01.02.2011 / K.Herd  
 Eigentum der Bernstein AG

\* Kleineres Maß in Höhe der Montageplatteauflage