

DECKEL/LID/COUVERCLE

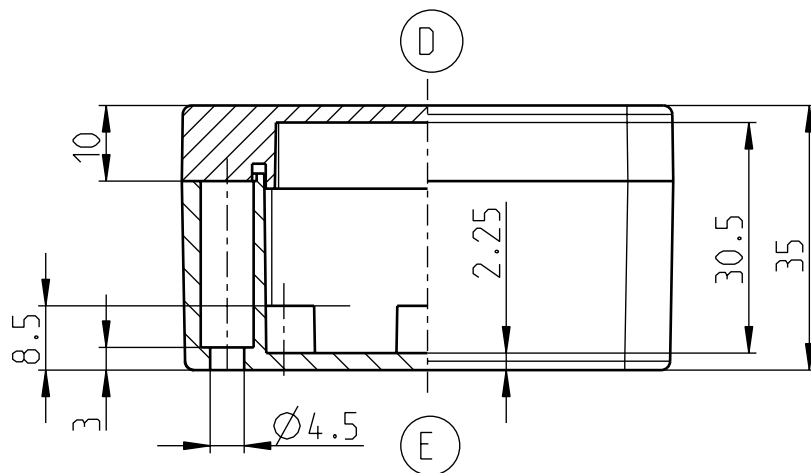

UNTERTEIL/BASE/PARTIE BASSE

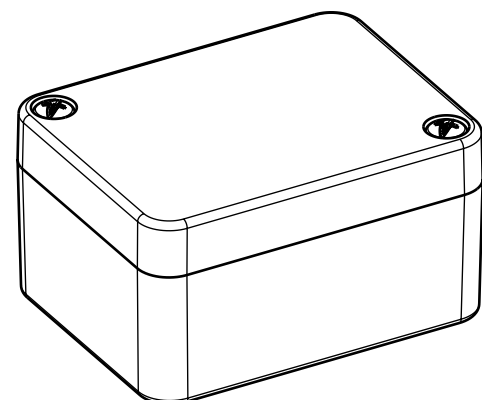
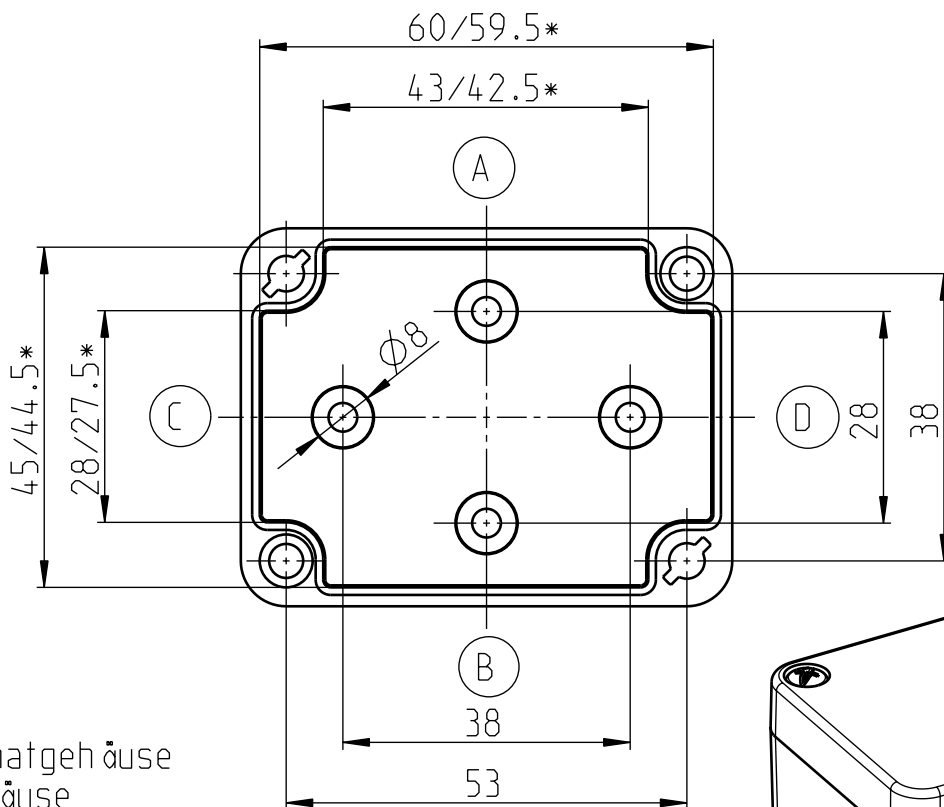

65x50x35
 CT-521 Polycarbonatgehäuse
 CT-522 ABS- Gehäuse
 erstellt am 31.01.2011 / K.Herd
 Eigentum der Bernstein AG

* Kleineres Maß in Höhe der Montageplatteauflage