

DECKEL/LID/COUVERCLE

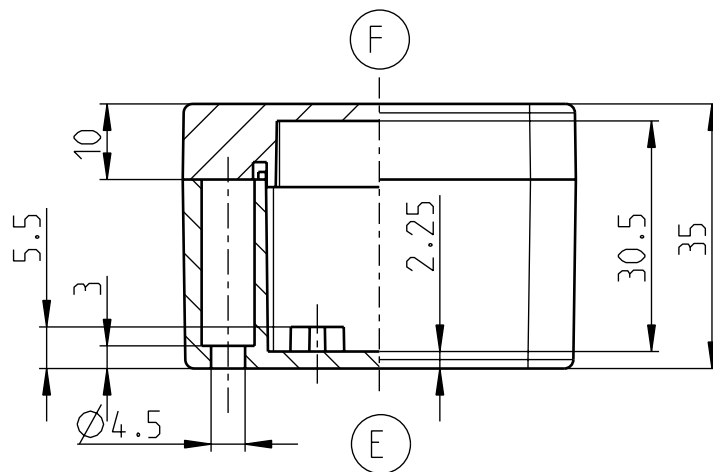

UNTERTEIL/BASE/PARTIE BASSE

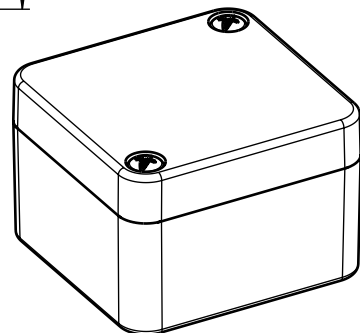
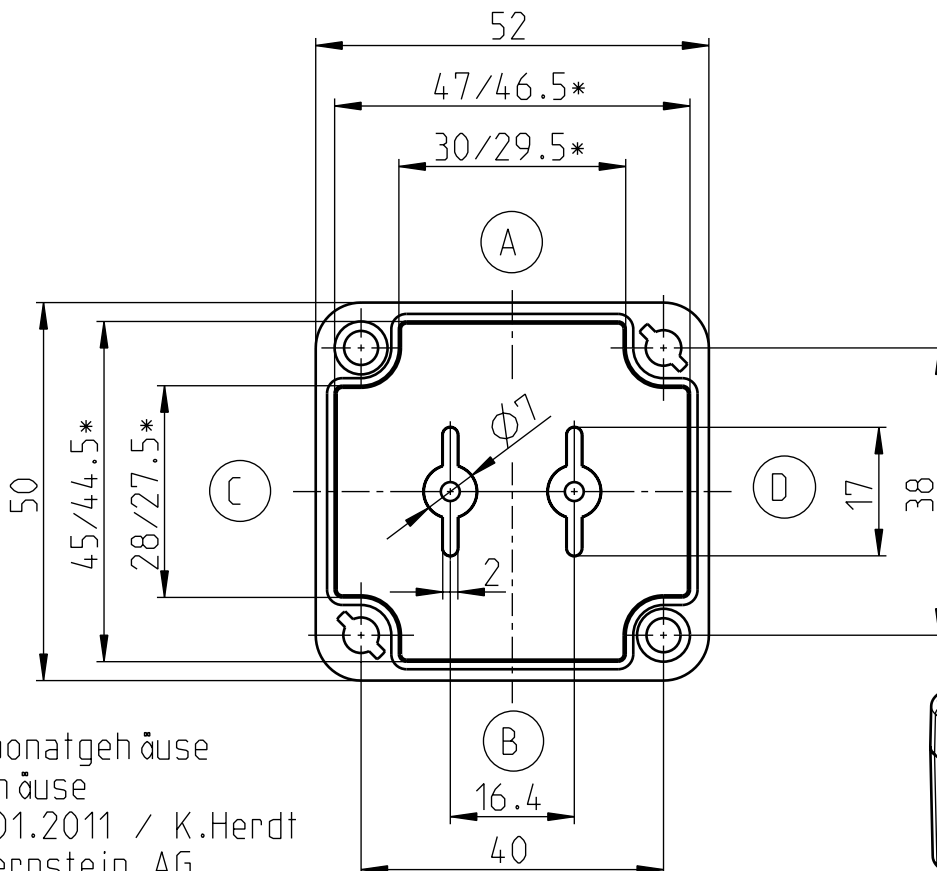

52x50x35
 CT-501 Polycarbonatgehäuse
 CT-502 ABS-Gehäuse
 erstellt am 31.01.2011 / K.Herdt
 Eigentum der Bernstein AG

*Kleineres Maß in Höhe der Montageplatteauflage