

Inductive Proximity Switch - Namur Series M12

Description **KIB-M12EA/002-10**

Article number **6601624396**

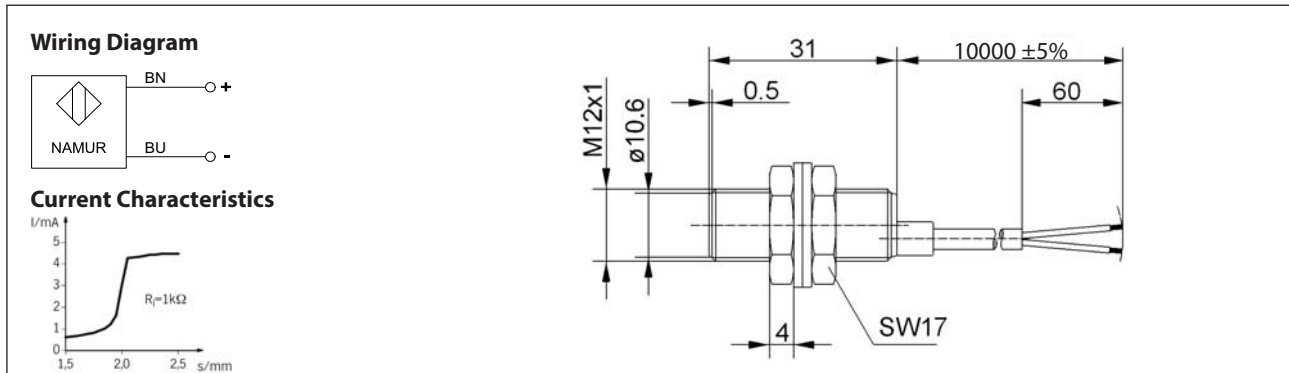

Identifying characteristics in accordance with DIN EN 60947-5-6

Electrical data		
Mounting		flush
Rated operating distance	S_n	2 mm (switching point 1,5mA @ $U_n = 8V$ and $R_i = 1k\Omega$)
Standard target		12 mm x 12 mm, t = 1 mm, material: FE360
Repeat accuracy	R	≤ 5 %
Rated voltage	U_n	DC 8 V
Rated operational voltage	U_e	DC 5 ... 25 V
Ripple		≤ 5 %
Current input		> 3 mA ($U_n = 8V$ and $R_i = 1k\Omega$) sensing face free < 1 mA ($U_n = 8V$ and $R_i = 1k\Omega$) sensing face damping
Frequency of operating cycles	f	≤ 800 Hz
Self-inductance	L_i	100 μ H
Self-capacitance	C_i	55 nF
Vibratory stresses		10-55 Hz, a=1 mm
Shock resistance		30 g, $t_{stoss}=11$ ms

Mechanical Data	
Front cap	PA 6.6, blue
Enclosure	Brass, nickel plated
End cap	PA 6, blue
Ambient air temperature	-25 °C ... +70 °C
Type of protection	IP67
Termination type	Cable 2 x 0,25 mm ² , PVC-Outer jacket, blue
For attachment	2 x hexagon nut and 2 x toothed washer

EU Conformity	
acc. to directive 2014/30/EU	