

Type: **MEM-63NP2-10.4-2/KL**Art.-Nr.: **637.1263.051**

19.05.99/0589

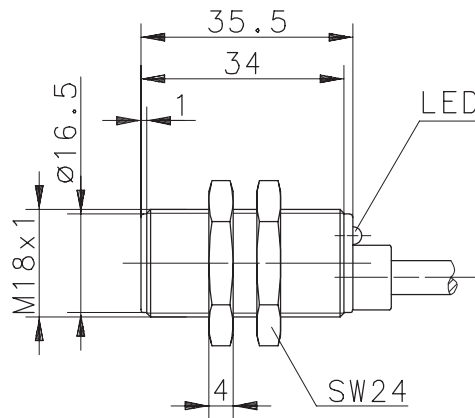
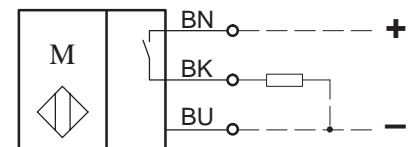

			min.	typ.	max.
Schaltpunkt [mT]	B_{OP}		+3,0	+10,0	+17,5
Rückschaltpunkt [mT]	B_{RP}		+1,0	+4,5	+14,5
Hysterese [mT]	B_H		2,0	5,5	8,0
(-) Süd	(+) Nord				

Anschlußbild:**1. Betriebsdaten**

Betriebsspannung U_B : DC 10 ... 30 V; Verpolschutz
 Betriebsstrom : < 20 mA

2. Ausgangsdaten

Schaltungsart : 3 – Leiter, plusschaltend
 Schaltstrom max. : 400 mA, kurzschlußfest
 Spannungsabfall U_d : < 3 V
 Ausgangsfunktion : PNP, Schließer; Betätigung durch Nordpol

3. Betriebs- und Umgebungsbedingungen

Temperaturbereich : -20 °C bis +70 °C
 Schutzart : IP 67 nach IEC 529, EN 60529
 Gehäuse : CuZn39Pb3, vernickelt
 Anschlußart : Kabel 3 x 0,34 mm² x 2 m; PUR-Mantel, schwarz
 Funktionsanzeige : LED gelb, Ausgangsanzeige / geschalteter Zustand

Type: **MEM-63NP2-10.4-2/KL**Art.-No.: **637.1263.051**

19.05.99/0589

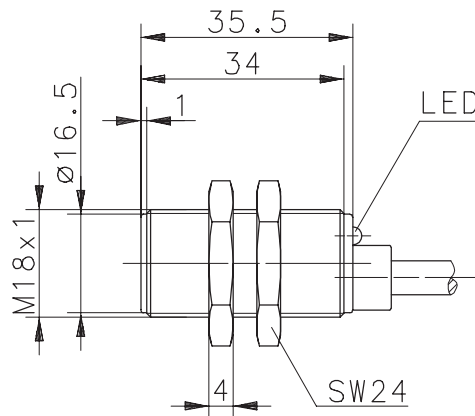

			min.	typ.	max.
Operate point	[mT]	B _{OP}	+3,0	+10,0	+17,5
Release point	[mT]	B _{RP}	+1,0	+4,5	+14,5
Hysteresis	[mT]	B _H	2,0	5,5	8,0
(-) South	(+) North				

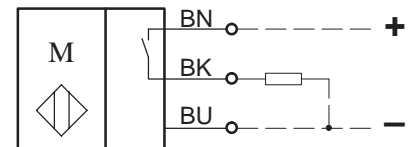
Wiring Diagram:**1. Operating Data**

operational voltage range U_B : DC 10 ... 30 V; supply reversal protection
 non-load supply current : < 20 mA

2. Output Data / Transistor

electrical output : 3 – wire, PNP
 rated operational current : 400 mA, short circuit protection
 voltage drop U_d : < 3 V
 output function : PNP, N.O.; actuated by northpole

3. Operating and Ambient Conditions

temperature range : -20 °C up to +70 °C
 protection : IP 67 to IEC 529, EN 60529 (NEMA 4)
 housing : CuZn39Pb3, nickel plated
 connection : Cable 3 x 0,34 mm² x 2 m; PUR – Outer jacket, black
 indication : LED yellow, output indication / switched position