

## Plastic bodied limit switch Series I49

Description **I49-SA1Z IW Z 1M**

Article number **6189752033**

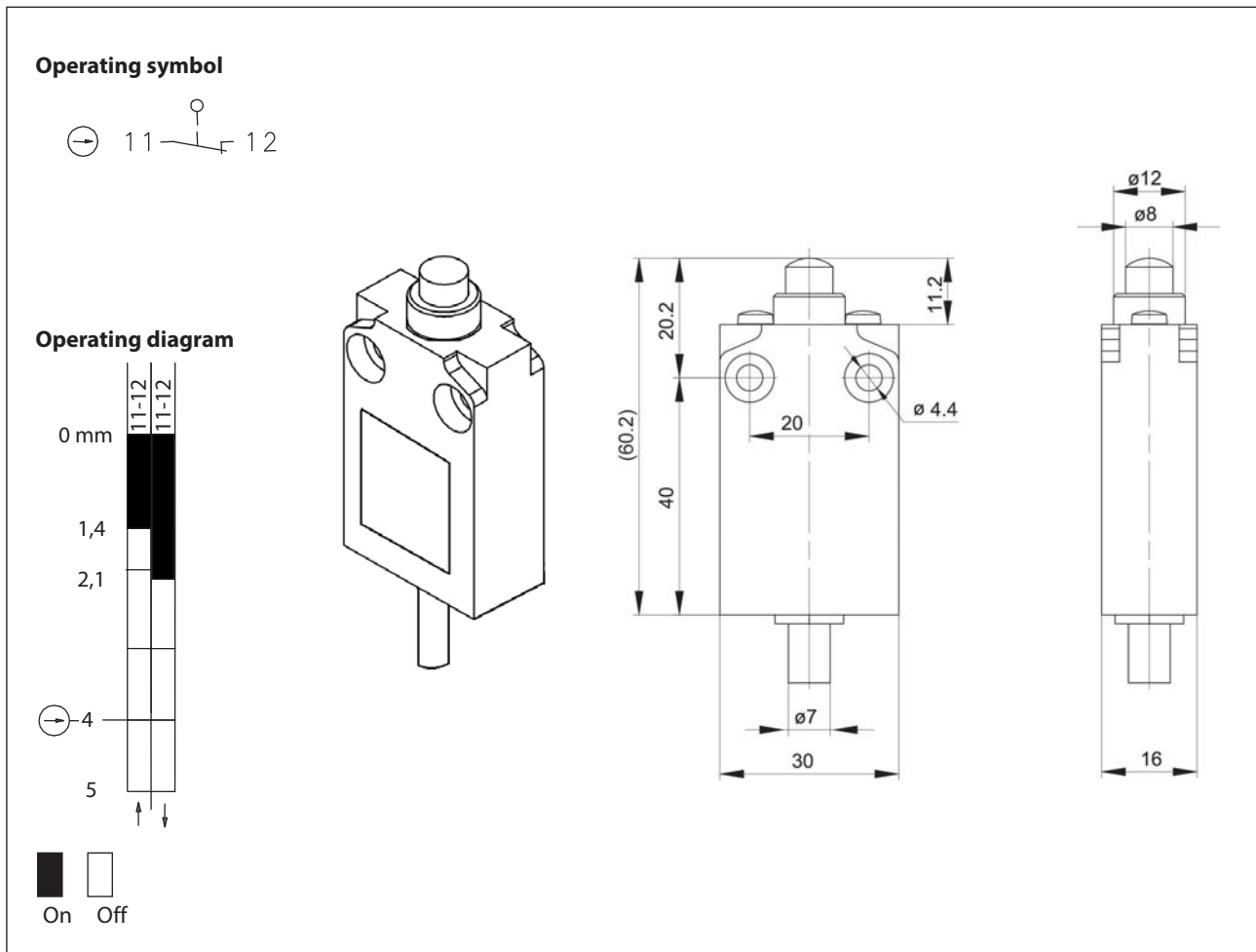

### Electrical Data

Rated insulation voltage acc. to DIN EN 60947-1	$U_i$ 400 V (degree of pollution 3)
Conv. thermal current acc. to DIN EN 60947-5-1) 0 < 40 °C	$I_{the}$ 10 A
Rated operational voltage	$U_e$ 240 V
Utilization category	AC-15, 24 V - 10 A / 240 V - 3 A DC-13, 24 V - 2.8 A / 125 V - 0.22 A / 250 V - 0.27 A
Direct opening action	$\ominus$ acc. to IEC/EN 60947-5-1
Short-circuit protective device $U_e < 500$ V a.c. - gG type fuses	Fuse 10 A gG
Protection class	II, totally insulated

<b>Mechanical data</b>	
Enclosure	Pre-wired, Double insulation, Plastic Casing IP67, 30 mm width (polymeric)
Actuator	Plunger (nikel-plated)
Ambient air temperature	
-during operation	-25 °C ... +70 °C
-for storage	-40 °C ... +70 °C
Contact type	Snap action, 1 NC
Mechanical life	10 x 10 <sup>6</sup> switching cycles
Switching frequency	60 / min
Velocity for actuating	0,5 m/s
Resistance between contacts	< 25 mΩ
Connection	PVC 2 x 0,75 mm <sup>2</sup> cable, 1 m length, 50 mm stripped
Installation position	All positions are authorized
Protection type	IP67 acc. to IEC/EN 60529

<b>Standards</b>	
	DIN EN 60947-1
	DIN EN 60947-5-1

<b>EU Conformity</b>	
	acc. to directive 2014/35/EU