

Foot-switch
Series KFM2

Description **KFM2-SU1/SU1 GEBL**

Article number **616920002**

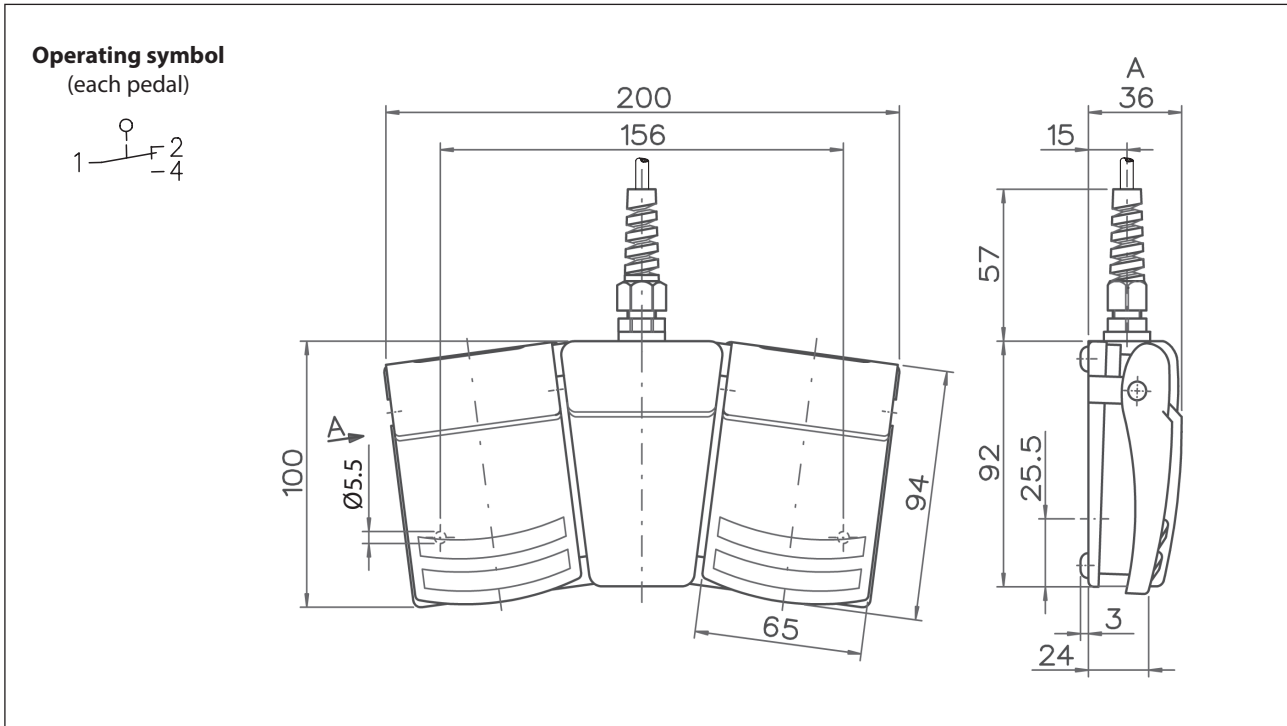

Electrical data

Rated operational current	I_e	4 A
Rated operational voltage	U_e	240 V AC
Protection class		II, fully insulated

Mechanical Data	
Enclosure	PA6.6 glass fibre reinforced, black-gray (RAL 7021)
Actuator	left foot lever PA6.6 glass fibre reinforced, rape yellow (RAL 1021) right foot lever PA6.6 glass fibre reinforced, sky blue (RAL 5015)
Ambient air temperature	-20 °C ... +80 °C
Contact type (each pedal)	1 changeover
Mechanical life	1 x 10 ⁶ switching cycles
Connection	PVC-control cable, composition corresponds to H05VV-F, S=0,5 mm ² , black, length 3 m
Number of connections	6
Conductor cross-sections	0,5 mm ²
Cable entry size	1 x cable gland M12 x 1,5 with bend protection
Protection type	IP 65 acc. to IEC/EN 60529

Standards
DIN EN 61058-1

EU Conformity
acc. to directive 2014/35/EU

Notes
The degree of protection (IP code) specified applies only to a properly closed cover.