

# Technical Data

## Safety switch

### Series SK – with separate actuator

Description **SK-A2Z**

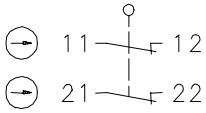

Article number **6016169179**

Operating symbol

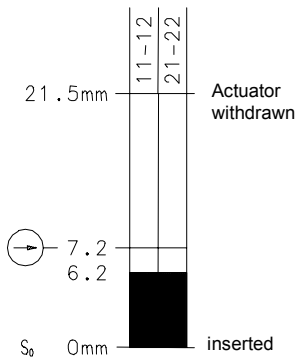

Operating diagram



  Tolerances  
 Operating point:  $\pm 0,25\text{mm}$ ;  
 Actuating force:  $\pm 10\%$

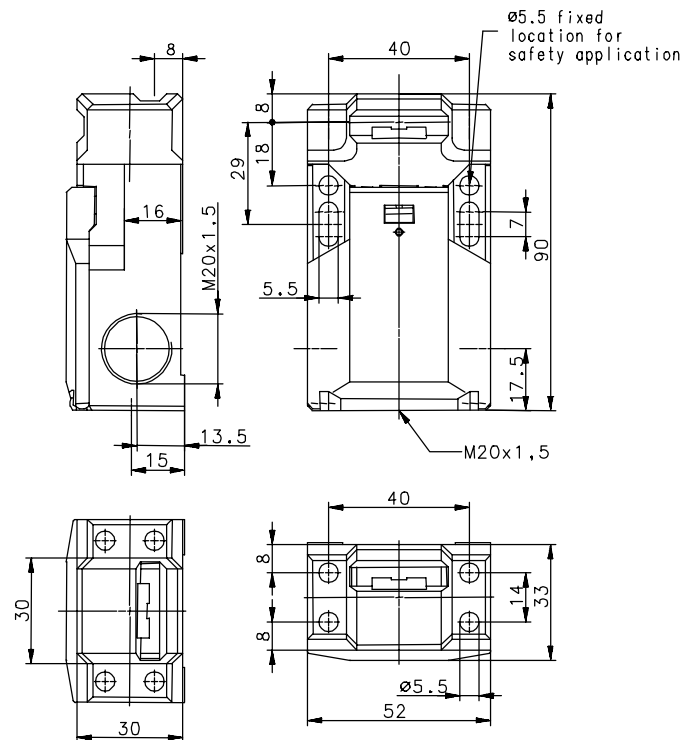

#### Electrical data

Rated insulation voltage	$U_i$	250 VAC
Conv. thermal current	$I_{the}$	10A
Utilization category		AC-15, $U_e/I_e$ 240V/3A
Direct opening action		according to IEC/EN 60947-5-1, Annex K
Short-circuit protective device		Fuse 6A gL/gG
Protection class		II, totally insulated

This document will not become the contractual basis; the details included herein do not constitute any descriptions of expected conditions, so that warranties/claims for defects on account of possible variations of the actual qualities from the qualities described herein are explicitly excluded. All rights reserved. Specifications subject to change without notice!

Date of issue: 10.05.2005 / Page 1 of 2  
 Document : 6116169179\_en / Last update: 1 / 2341-05

### Mechanical data

Enclosure	Thermoplastic, glass fibre reinforced (UL94-V0)
Cover	Thermoplastic, glass fibre reinforced (UL94-V0)
Actuator	Separate actuator
Extraction force	10N
Ambient air temperature	-30°C ... +80°C
Contact type	2 NC (Zb)
Mechanical life	1 x 10 <sup>6</sup> switch operations
Switching frequency	≤ 30 / min.
Assembly Safety switch	2 x M5
Connection	4 screw connections (M3,5)
Conductor cross-sections	Solid: 0,5 ... 1,5mm <sup>2</sup> Litz wire with ferrules: 0,5 ... 1,5mm <sup>2</sup>
Cable entrance	3 x M20 x 1,5
Weight	≈ 0,13kg
Installation position	Operator definable
Protection type	IP65 acc. to IEC/EN 60529

### Actuation

Turning the cap (pos A/B) allows 4 different directions of drive.  
Cover (1) has to be opened before turning the cap (2).  
Insert the screwdriver into the gap between housing and cap and turn until the cap snaps off.  
Remove the cap, turn it 180° (4), latch it into the housing and close the cover.

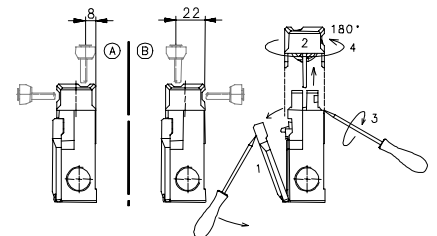

### Standards

VDE 0660 T100, DIN EN 60947-1, IEC 60947-1  
VDE 0660 T200, DIN EN 60947-5-1, IEC 60947-5-1  
GS-ET 15

### EU Conformity



### Approvals

UL/CSA A300 (same polarity)

### Notes

The degree of protection (IP code) specified applies solely to a properly closed cover and the use of an equivalent cable gland with adequate cable.  
The switch may not be used as a mechanical stop.  
Radial actuation may reduce the mechanical life.  
Tapped holes not in use must be closed with blind plugs.  
Only for use with Bernstein-actuator.

Customer specific label (ID-No.: GKNC6L)

