

Technical Data

Plastic bodied limit switch

Series I

Description **I-U1Z RIW**

Article number **6083117019**

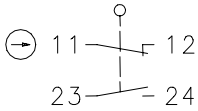

Operating symbol

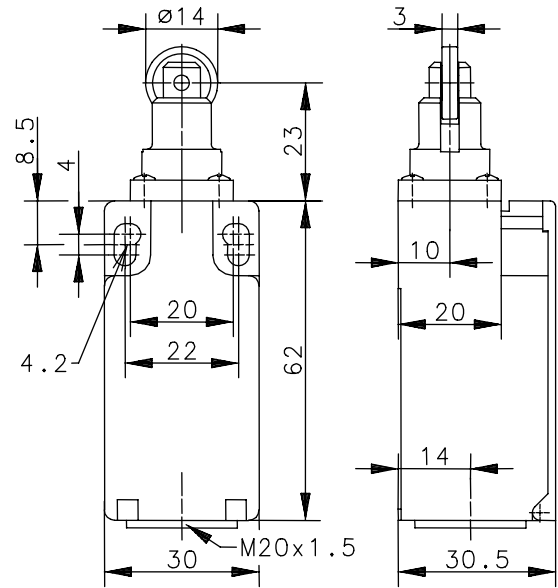
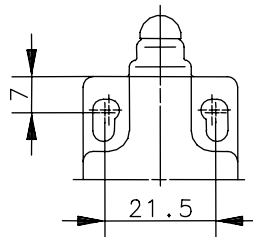
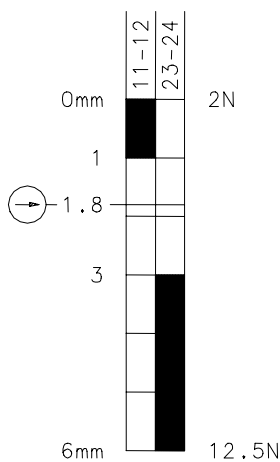

Fixed positioning for safety applications
Mounting screw according to DIN 912 M5

Operating diagram



  Tolerance:
 On Off Operating point $\pm 0,25\text{mm}$;
 Actuating force $\pm 10\%$

Electrical data

Rated insulation voltage	U_i	250V AC
Conv. thermal current	I_{the}	10A
Rated operational voltage	U_e	240V
Utilization category		AC-15, U_e/I_e 240V/3A
Positive opening NC contact		acc. to IEC/EN 60947-5-1, Annex K
Short-circuit protective device		Fuse 10A gL/gG
Protection class		II, totally insulated

This document will not become the contractual basis; the details included herein do not constitute any descriptions of expected conditions, so that warranties/claims for defects on account of possible variations of the actual qualities from the qualities described herein are explicitly excluded. All rights reserved. Specifications subject to change without notice!

Date of issue: 20.03.2007 / Page 1 of 2
Document : 6083117019_en.doc / Last update : 1 / 2204-07

Technical Data

Plastic bodied limit switch

Mechanical data

Enclosure	Thermoplastic, glass fibre reinforced (UL 94-V0)
Cover	Thermoplastic, glass fibre reinforced (UL 94-V0)
Actuator	Roller (thermoplastic)
Ambient air temperature	-30°C ... +80°C
Contact type	1 NC, 1 NO (Zb)
Mechanical life	10 x 10 ⁶ switching cycles
Switching frequency	≤ 100/min
Assembly	2 x M4
Connection	4 screw connections (M3,5)
Conductor cross-sections	Solid: 0.5 ... 1.5mm ² Litz wire with ferrules: 0.5 ... 1.5mm ²
Cable entrance	1 x M20x1,5
Weight	≈ 0,07kg
Installation position	Operator definable
Protection type	IP65 acc. to EN 60529; DIN VDE 0470 T1

Actuation

The actuating device is preferably started from 2 sides.

By loosening the 4 screws the actuation assembly can be rotated in 90 degree increments such that 4 actuation directions are possible.

The actuation assembly is to be again fastened to the housing using the 4 screws.

Standards

VDE 0660 T100, DIN EN 60947-1, IEC 60947-1
VDE 0660 T200, DIN EN 60947-5-1, IEC 60947-5-1

EU Conformity

CE

Approvals

cCSA_{US} A300 (same polarity)

Notes

The degree of protection (IP code) specified applies solely to a property closed cover and the use of an equivalent cable gland with adequate cable.