

Accessories

Float

Description **SCHW-ZYL.KPL.RD23X25**

Article number **4945211024**

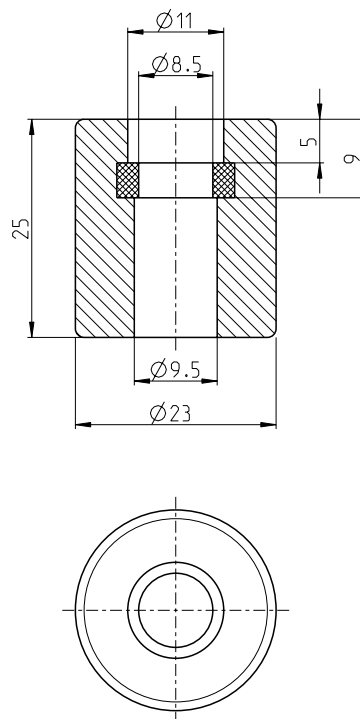

Technical data

Float material	NBR
- density	about 0,7 g/cm ³ ±10 %
- depth of immersion	16 mm ± 2 mm (to a fluid-density of 1 g/cm ³)
Magnetic material	Hartferrit 7/21
Temperature range	-5 °C ... +60 °C
Max. pressure	10 bar